

# Thru-beam sensor

## BB10-P-F1/33/35/59/102/115-7m



- Single-beam miniature photoelectric sensor, ideal for installing in frames or contours
- Integrated circuit
- Plug-in style housing for 13 mm hole
- Narrow opening angle, suitable for mounting in pairs
- Various frequencies for avoiding mutual interference (cross-talk immunity)
- Dark on version

Miniature photoelectric sensor with plug-in style housing for mounting in 13 mm hole



### Function

There is no simpler way of installing a sensor: drill the hole, clip in the sensor and you're done. What's more, the BB10 plug-in sensors for doors and turnstiles offer top performance at an extremely attractive price. The switching mechanism is integrated in the compact, self-contained and temperature-stable housing, making the BB10 suitable even for extremely cold regions with temperatures as low as -40°C.

### Application

- Monitoring function for turnstiles
- Activation function for restarting escalators
- Monitoring of industrial gates
- Person detection for automatic doors and gates

### Dimensions

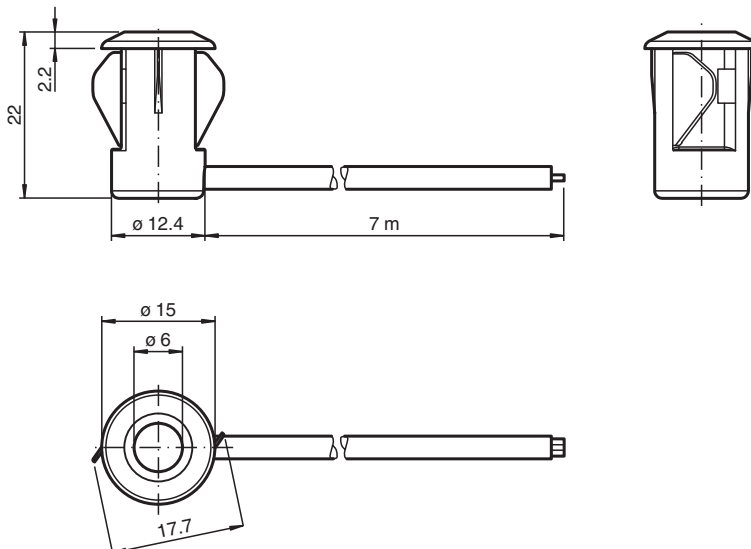

Release date: 2023-05-09 Date of issue: 2023-05-09 Filename: 809334\_eng.pdf

Refer to "General Notes Relating to Pepperl+Fuchs Product Information".

Pepperl+Fuchs Group  
www.pepperl-fuchs.com

USA: +1 330 486 0001  
fa-info@us.pepperl-fuchs.com

Germany: +49 621 776 1111  
fa-info@de.pepperl-fuchs.com

Singapore: +65 6779 9091  
fa-info@sg.pepperl-fuchs.com

**PF** PEPPERL+FUCHS

## Technical Data

<b>System components</b>		
Emitter		BB10-T-F1/33/35/115-7m
Receiver		BB10-R-F1/33/35/59/102/115-7m
<b>General specifications</b>		
Effective detection range		0 ... 3 m
Threshold detection range		4 m
Light source		IRED
Light type		modulated infrared light , 880 nm
Diameter of the light spot		approx. 350 mm at a distance of 3 m
Opening angle		Emitter: +/- 3 ° Receiver: +/- 10 ° at max. sensing range ; typical
Optical face		frontal
Ambient light limit		halogen light 100000 Lux ; according to EN 60947-5-2:2007
<b>Functional safety related parameters</b>		
MTTF <sub>d</sub>		795 a
Mission Time (T <sub>M</sub> )		20 a
Diagnostic Coverage (DC)		0 %
<b>Indicators/operating means</b>		
Function indicator		LED red: lights up when receiving the light beam ; flashes when falling short of the operating reserve; OFF when light beam is interrupted
<b>Electrical specifications</b>		
Operating voltage	U <sub>B</sub>	10 ... 30 V DC
No-load supply current	I <sub>0</sub>	Emitter: ≤ 20 mA Receiver: ≤ 10 mA
<b>Output</b>		
Switching type		dark-on
Signal output		1 NPN output, short-circuit protected, reverse polarity protected, open collector
Switching voltage		max. 30 V DC
Switching current		max. 100 mA
Voltage drop	U <sub>d</sub>	≤ 1.5 V DC
Switching frequency	f	100 Hz
Response time		5 ms
<b>Conformity</b>		
Product standard		EN 60947-5-2
<b>Approvals and certificates</b>		
CCC approval		CCC approval / marking not required for products rated ≤36 V
UN/ECE Regulation No. 10 (E1)		Type-approval number: 036938
<b>Ambient conditions</b>		
Ambient temperature		-40 ... 60 °C (-40 ... 140 °F) , fixed -20 ... 60 °C (-4 ... 140 °F) , movable
Storage temperature		-40 ... 70 °C (-40 ... 158 °F)
Relative humidity		90 % , noncondensing
<b>Mechanical specifications</b>		
Degree of protection		IP67
Connection		7 m fixed cable Receiver: grey ; Emitter: black
<b>Material</b>		
Housing		PC , black
Optical face		Plastic pane
Mass		approx. 100 g per device

**Connection Assignment**

**Emitter**

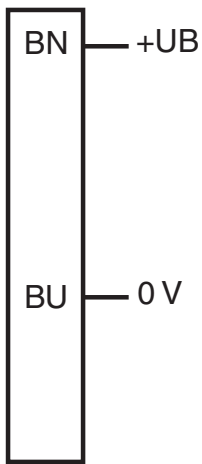

**Receiver**

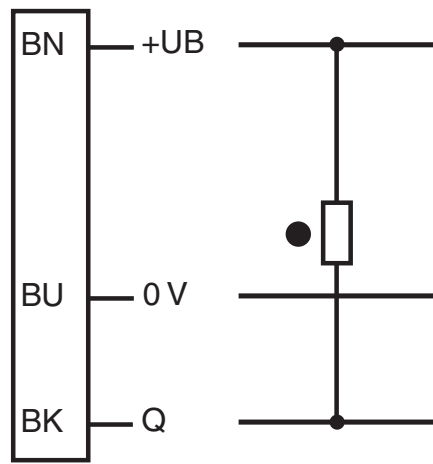

○ = Light on  
● = Dark on

**Assembly**

Back of Receiver

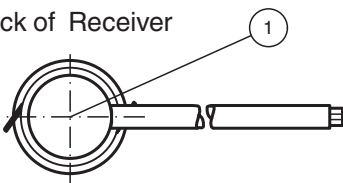

1	Signal display	red
---	----------------	-----

**Characteristic Curve**

**Characteristic response curve**

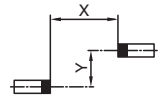
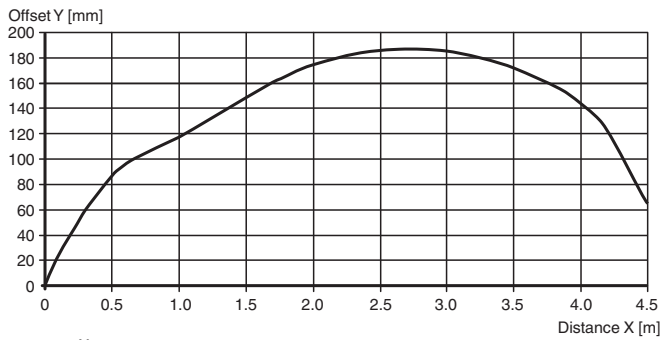

Release date: 2023-05-09 Date of issue: 2023-05-09 Filename: 809334\_eng.pdf

## Characteristic Curve

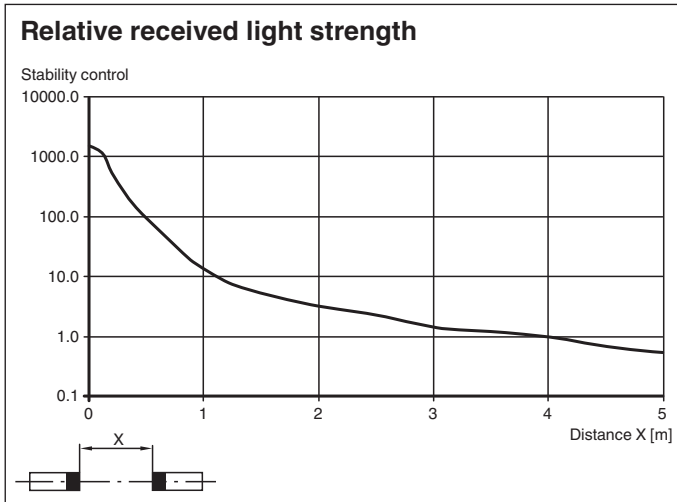

## Function Principle

The thru-beam sensor requires two devices for operation; an emitter and a receiver. The emitter and receiver must be optically aligned with one another in a single line. The infrared light emitted from the emitter is recorded by the receiver and evaluated. The sensor detects both people and objects for as long as an object interrupts the detection beam, regardless of movement and surface structure.

Release date: 2023-05-09 Date of issue: 2023-05-09 Filename: 809334\_eng.pdf

**Additional Information**

**Static detection:**

The sensor detects both people and objects for as long as an object interrupts the detection beam, regardless of movement and surface structure.

		Electronic output
Light ON /25	Person located within beam	Inactive
	No people located within beam	Active
Dark ON /59	Person located within beam	Active
	No people located within beam	Inactive

**Optics:**

The relatively wide opening angles allow the sensors to be mounted quickly without any alignment issues. Function is maintained even if mounting profiles are slightly distorted.

**Mounting:**

Thanks to its compact dimensions, the sensor fits in U profiles or behind any covers.

Sheet thickness [mm]	Hole diameter [mm]	
	13	13.5
1	OK	X
2	OK	OK
3	OK	OK

X = mounting not possible

OK = mounting possible

**Mounting for dual-beam protection:**

For dual-beam versions, two light sources and receivers are required.

When using thru-beam sensors with two different transmission frequencies (F1 and F2), it is not necessary to observe a minimum beam distance between the thru-beam sensors.

When using thru-beam sensors with the same transmission frequency:

Ensure that the minimum beam distance is 20 cm and that the transmitter and receiver are arranged in a cross formation.

