

# Thru-beam sensor

## ML300-P-6m-RT/25/98/103



- Miniature design
- Easy to use
- Visible red light
- 45° connector

Thru-beam sensor for basic applications, miniature design, 6 m detection range, red light, light on, PNP output, M8 plug



### Function

The ML300 series has a robust miniature housing and all the standard functional principles. Of particular note are the sensors with analog output, which return a value proportional to the distance. The 45° plug/cable connection ensures flexible mounting. An LED indicates a weak signal, e.g. due to dirt.

### Dimensions

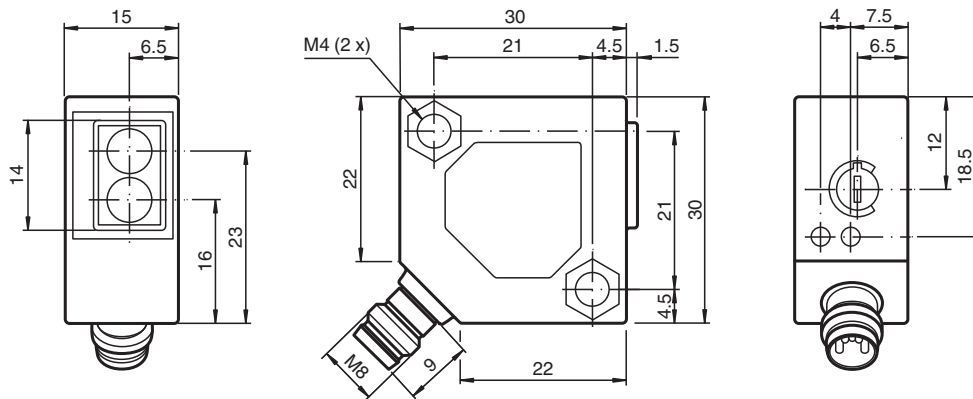

Release date: 2023-04-04 Date of issue: 2023-04-04 Filename: 238206\_eng.pdf

Refer to "General Notes Relating to Pepperl+Fuchs Product Information".

Pepperl+Fuchs Group  
www.pepperl-fuchs.com

USA: +1 330 486 0001  
fa-info@us.pepperl-fuchs.com

Germany: +49 621 776 1111  
fa-info@de.pepperl-fuchs.com

Singapore: +65 6779 9091  
fa-info@sg.pepperl-fuchs.com

**PF** PEPPERL+FUCHS

## Technical Data

<b>System components</b>		
Emitter		ML300-T-6m-RT/98
Receiver		ML300-R-6m-RT/25/98/103
<b>General specifications</b>		
Effective detection range		0 ... 6 m
Threshold detection range		8 m
Light source		LED
Light type		modulated visible red light 660 nm
Diameter of the light spot		approx. 500 mm at 6 m
Opening angle		approx. 5 °
Ambient light limit		
Continuous light		10000 Lux
Modulated light		5000 Lux
<b>Indicators/operating means</b>		
Function indicator		LED yellow: lights up when output is active LED green: Sufficient stability control
Control elements		sensitivity adjustment
<b>Electrical specifications</b>		
Operating voltage	$U_B$	10 ... 30 V DC
Ripple		max. 10 %
No-load supply current	$I_0$	Emitter: ≤ 20 mA Receiver: ≤ 20 mA
<b>Output</b>		
Switching type		light-on
Signal output		1 PNP output, short-circuit protected, reverse polarity protected, open collector
Switching voltage		max. 30 V DC
Switching current		max. 0.1 A
Voltage drop	$U_d$	≤ 2 V DC
Switching frequency	$f$	1000 Hz
Response time		0.5 ms
<b>Conformity</b>		
Product standard		EN 60947-5-2
<b>Compliance with standards and directives</b>		
Standard conformity		
Shock and impact resistance		EN 60947-5-7 30 g, 11 ms, all axes
Vibration resistance		EN 60947-5-7, 10-55 Hz/1.5 mm amplitude, all axes
<b>Approvals and certificates</b>		
CCC approval		CCC approval / marking not required for products rated ≤36 V
<b>Ambient conditions</b>		
Ambient temperature		-25 ... 55 °C (-13 ... 131 °F)
<b>Mechanical specifications</b>		
Housing width		30 mm
Housing height		30 mm
Housing depth		15 mm
Degree of protection		IP65
Connection		M8 x 1 connector, 3-pin
Material		
Housing		ABS
Optical face		plastic
Connector		metal
Mass		35 g (emitter and receiver)

**Connection Assignment**

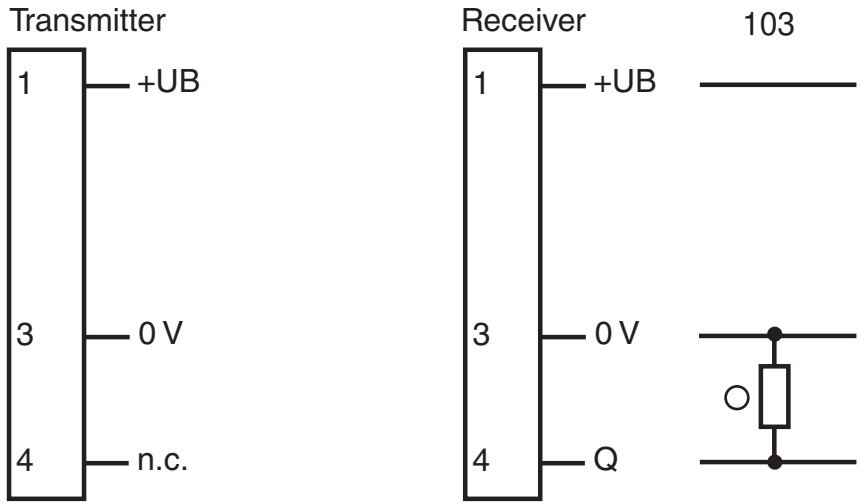

○ = Light on  
● = Dark on

**Connection Assignment**



Wire colors in accordance with EN 60947-5-2

- 1 | BN (brown)
- 3 | BU (blue)
- 4 | BK (black)

**Assembly**

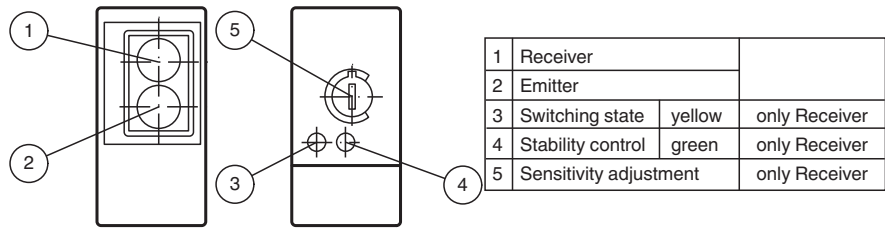

1	Receiver		
2	Emitter		
3	Switching state	yellow	only Receiver
4	Stability control	green	only Receiver
5	Sensitivity adjustment		only Receiver



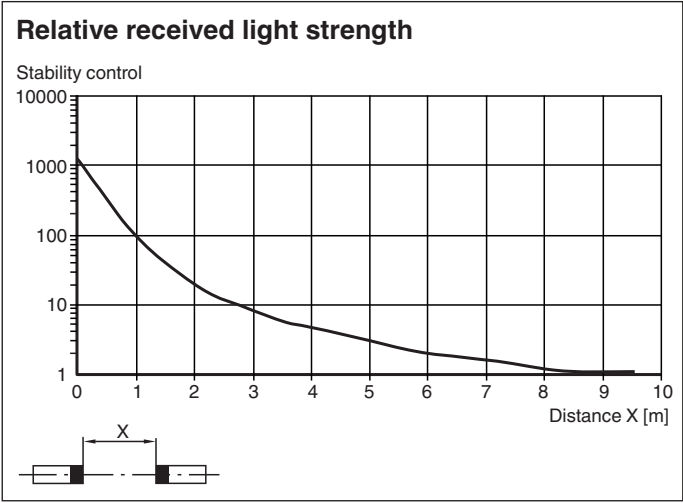
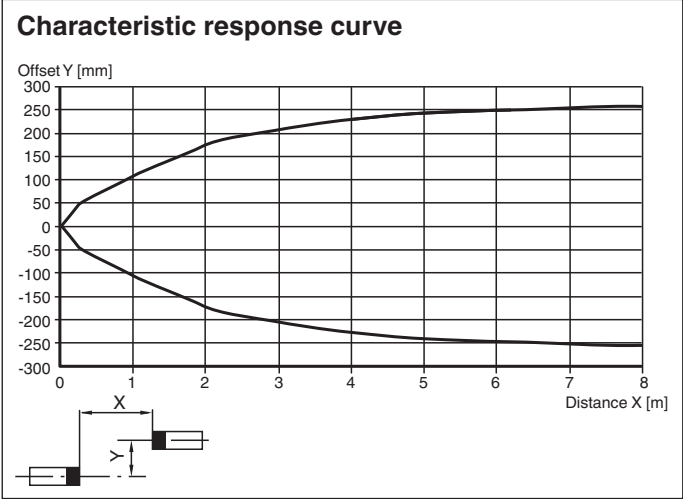

Release date: 2023-04-04 Date of issue: 2023-04-04 Filename: 238206\_eng.pdf

Refer to "General Notes Relating to Pepperl+Fuchs Product Information".

**Characteristic Curve**



**Accessories**

	<b>OMH-ML300-01</b>	Bracket for mounting ML300 series sensors
	<b>V3-GM-2M-PVC</b>	Female cordset single-ended M8 straight A-coded, 3-pin, PVC cable grey
	<b>V3-WM-2M-PVC</b>	Female cordset single-ended M8 angled A-coded, 3-pin, PVC cable grey
	<b>V3-WM-2M-PUR</b>	Female cordset single-ended M8 angled A-coded, 3-pin, PUR cable grey

Release date: 2023-04-04 Date of issue: 2023-04-04 Filename: 238206\_eng.pdf

Refer to "General Notes Relating to Pepperl+Fuchs Product Information".