

# AS-Interface I/O module

## VBA-4E4A-G20-ZEJ/M3L-P10



- A/B node with extended addressing possibility for up to 62 nodes
- Inputs for 3-wire sensors
- Outputs for DC roller motors (drum motors)
- Connection of motors and sensors via M8 connectors
- Configurable start/stop ramps
- Communication monitoring
- Power supply of outputs from the external auxiliary voltage
- Supply for inputs from AS-Interface
- Function display for bus, external auxiliary voltage, in- and outputs
- Cable piercing method with gold plated contact pins

G20 motor control module for Itoh Denki PM500XE and PM500XP



### Function

The AS-Interface connecting module is a field module with two sensor inputs and two electronic outputs for controlling DC roller motors of the type ITOH Denki PM...XE/XP or compatible.

The compact housing can be installed directly into support profiles or cable ducts.

It is connected to the AS-Interface network and the auxiliary energy using insulation piercing technology via the AS-Interface flat cable.

The swiveling flat cable guide is locked without the use of tools. The sensor inputs and motor outputs are connected using cable outputs with M8 round plug connectors.

The inputs are supplied via the AS-Interface. The motors are supplied via the external auxiliary voltage  $U_{AUX}$ .

The current switching state of the sensor inputs, the presence of supply voltage at the motors, the operating state of the motors (stationary/in operation) and the direction of rotation is displayed via LEDs. Using AS-Interface data bits, the motors can be switched on or off individually, the direction of rotation can be changed, and the speed of the motor can be controlled. The voltage for the speed signal and a separate direction of rotation for motor 2 can be controlled via AS-Interface parameters.

To control the acceleration and to stop the motors, a start/stop ramp can be set for the speed signal. The time period of the ramp can be selected from eight preset values and can be configured. Once selected, the ramp is stored in non-volatile memory and automatically activated after each switch-on. The ramp is not effective if the direction of rotation signal is switched when the motor is running. In this case, the direction of rotation is reversed immediately.

#### Note:

The communication monitor of the module deactivates the outputs if the AS-Interface does not communicate with the module for more than 40 ms. Inputs IN1 and IN2 suppress pulses that are shorter than 2 ms. An overload of the input supply, an overload of the speed signal, or a lack of external auxiliary voltage is reported to the AS-Interface master. The communication via AS-Interface remains unaffected.

### Dimensions

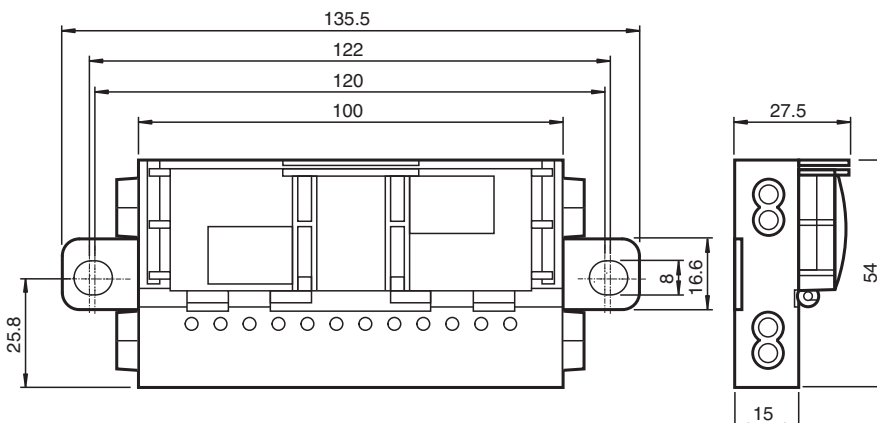

### Technical Data

#### General specifications

Release date: 2023-07-13 Date of issue: 2023-07-13 Filename: 70130650\_eng.pdf

Refer to "General Notes Relating to Pepperl+Fuchs Product Information".

Pepperl+Fuchs Group  
www.pepperl-fuchs.com

USA: +1 330 486 0001  
fa-info@us.pepperl-fuchs.com

Germany: +49 621 776 1111  
fa-info@de.pepperl-fuchs.com

Singapore: +65 6779 9091  
fa-info@sg.pepperl-fuchs.com

PEPPERL+FUCHS

## Technical Data

Node type	A/B node	
AS-Interface specification	V3.0	
Required gateway specification	≥ V3.0	
Profile	S-7.A.7	
IO code	7	
ID code	A	
ID1 code	7	
ID2 code	7	
UL File Number	E223772 "For use in NFPA 79 Applications only"	
MTBF	98 a	
Compatible roller motors	Itoh Denki PM*XP, Itoh Denki PM*XE	
<b>Indicators/operating means</b>		
LED FAULT	error display; LED red red: communication error or address is 0 red flashing: overload of sensor supply or speed signal overload or external auxiliary voltage $U_{AUX}$ missing	
LED PWR	AS-Interface voltage; green LED green: voltage OK green flashing: address 0 or sensor supply overload or speed signal overload or external auxiliary voltage $U_{AUX}$ missing	
LED AUX	ext. auxiliary voltage $U_{AUX}$ ; dual LED green/red green: voltage OK red: reverse voltage	
LED IN	switching state (input); 2 LED yellow	
LED FUSE	Motor power supply; 2 green LEDs	
LED DIR	Motor rotation direction; yellow LED	
LED MOT	Motor active; 2 yellow LEDs	
<b>Electrical specifications</b>		
Auxiliary voltage (output)	$U_{AUX}$	18 ... 30 VDC PELV
Rated operating voltage	$U_e$	26.5 ... 31.6 V from AS-Interface
Rated operating current	$I_e$	≤ 25 mA (without sensors) / max. 170 mA
<b>Input</b>		
Number/Type	2 Inputs for 3-wire sensors (PNP), DC	
Supply	from AS-Interface	
Current loading capacity	100 mA , overload and short-circuit protected	
Input current	≤ 6 mA (internally limited)	
Switching point	according to DIN EN 61131-2 0 (undamped) ≤ 0.5 mA 1 (damped) ≥ 2.0 mA	
Signal delay	< 1 ms (input/AS-Interface)	
Input filter	2 ms	
<b>Output</b>		
Number/Type	2 outputs for DC roller motors (MOT1, MOT2)	
Supply	from external auxiliary voltage $U_{AUX}$	
Current	3.5 A continuous current , 5 A (<2 s) , max. 7.5 A (<0,3 s) per motor	
Overload protection	Fuse 5 A, $I^2t = 53.7 \text{ A}^2\text{s}$ per motor	
Velocity signal	$U_S$	0 ... 10 V DC Control via parameter P1:0
Rotation direction signal	$U_D$	PNP digital output low: high impedance high: ≥ ( $V_{AUX} - 2.5 \text{ V}$ ) in no-load operation
Motor start signal	$U_R$	PNP digital output low: high impedance high: ≥ ( $V_{AUX} - 2.5 \text{ V}$ ) in no-load operation
<b>Directive conformity</b>		
Electromagnetic compatibility		
Directive 2014/30/EU	EN 62026-2:2013	
<b>Standard conformity</b>		
Degree of protection	EN 60529:2000	

Release date: 2023-07-13 Date of issue: 2023-07-13 Filename: 70130650\_eng.pdf

Refer to "General Notes Relating to Pepperl+Fuchs Product Information".

 Pepperl+Fuchs Group  
www.pepperl-fuchs.com

 USA: +1 330 486 0001  
fa-info@us.pepperl-fuchs.com

 Germany: +49 621 776 1111  
fa-info@de.pepperl-fuchs.com

 Singapore: +65 6779 9091  
fa-info@sg.pepperl-fuchs.com

 **PEPPERL+FUCHS**

## Technical Data

Fieldbus standard	EN 62026-2:2013
Input	EN 61131-2:2007
Emitted interference	EN 61000-6-4:2007
AS-Interface	EN 62026-2:2013
Noise immunity	EN 61000-6-2:2005, EN 61326-1:2006, EN 62026-2:2013
<b>Ambient conditions</b>	
Ambient temperature	-25 ... 70 °C (-13 ... 158 °F)
Storage temperature	-30 ... 85 °C (-22 ... 185 °F)
Relative humidity	85 % non-condensing
Climatic conditions	For indoor use only
Altitude	≤ 2000 m above MSL
Shock and impact resistance	30 g, 11 ms in 6 spatial directions, 3 shocks
Vibration resistance	0.35 mm / 2 g 10 ... 1000 Hz
Pollution degree	2
<b>Mechanical specifications</b>	
Degree of protection	IP54 according to EN 60529
Connection	<b>AS-Interface, AUX:</b> Insulation piercing technology Yellow flat cable/black flat cable <b>Inputs/outputs:</b> M8 round plug connector in accordance with EN 61076-2-104 <b>Inputs:</b> LF004-GS1-A (4-pin, bushing contacts, screw lock, A-coded) Matching connector: LM004-Gx1-A or similar <b>Outputs:</b> LF005-GS1-B (5-pin, bushing contacts, screw lock, B-coded) Matching connector: LM005-Gx1-B or similar
Mass	310 g
Mounting	2 clips with Ø 8 mm drill hole
Cable length	1 m
Note	The flat cable routing is designed for 100 actuation cycles

## Connection

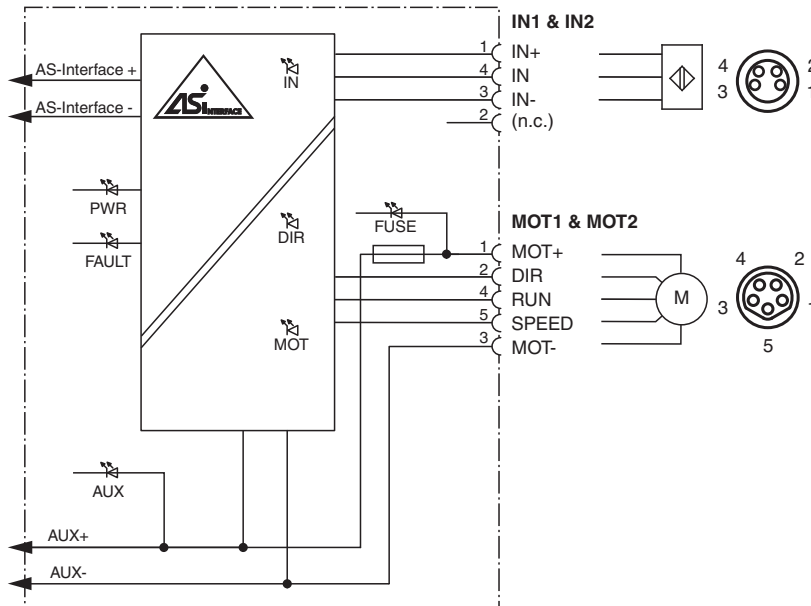

## Assembly

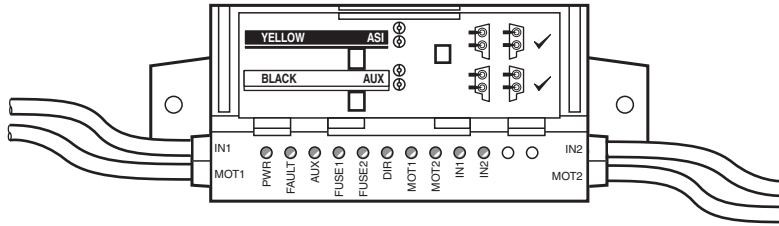

## Programming

### Data bits

(function via AS-Interface)

Data bits	Input	Output
D0	IN1	MOT1 operation
D1	IN2	MOT2 operation
D2	-	MOT1/MOT2 direction of rotation
D3	-	MOT1/MOT2 slow

### Parameter bit

(programmable via AS-Interface)

P1	P0	D0/D1	Speed signal $U_s$	
			fast (D3=0)	slow (D3=1)
x	x	0	< 1 V	< 1 V
0	0	1	4,7 V	0,7 V
0	1	1	5,7 V	1,7 V
1	0	1	7,7 V	2,7 V
1	1	1	9,7 V	3,7 V; default setting

P2	MOT1/MOT2 direction of rotation
1	synchronized; default setting
0	counter-rotating; direction of rotation MOT2 inverted

### Start/Stop ramp

8 ramps can be configured by AS-Interface parameters/data sequence.

### Incline

Constant, independent of terminal velocity.

The ramp duration defines the time from stationary to max. speed ( $U_s = 10$  V) or from max. speed to stationary. When the terminal velocity is lower, the ramp duration is shorter.

Ramp no.	Ramp duration
0	No Ramp; default setting
1	50 ms
2	100 ms
3	200 ms
4	300 ms
5	500 ms
6	1000 ms
7	1500 ms

### Ramp configuration

Non-volatile

### Time frame

10 s after setting D-OUT=4

### Hold time

Data/parameters: 10 ms per step

### Display

Configuration mode activated: Two LEDs, MOT1 and MOT2, flash

Step	P2:0	D3:0-OUT	D3:0-IN	Comment
1	3	4	x	
2	1	4	x	

## Programming

Step	P2:0	D3:0-OUT	D3:0-IN	Comment
3	6	4	x	
4	3	4	x	
5	1	4	x	
6	6	4	11xx = C...F	Configuration mode activated
7	6	Ramp no.	11xx = C...F	Ramp no. 0 ... 7 (see above)
8	4	Ramp no.	10xx = 8...B	Ramp no. stored in non-volatile memory
9	7	0	x	Normal operation







### Troubleshooting

If an error occurs in the defined sequence of parameter or data values during steps 1 to 6, the module remains in normal operation.

If an error occurs in steps 7 or 8, the module outputs the value D-IN = 01xx = 4...7 and waits until P = 7 and D-OUT = 0 is set before it returns to normal operation.

If P = 7 and D-OUT = 0 is already set in step 7 or 8, the module switches to normal operation immediately without the output D-IN = 01xx = 4...7. The stored ramp is not changed.

## Accessories

	<b>VBP-HH1-V3.0-KIT</b>	AS-Interface Handheld with accessory
	<b>VAZ-PK/G20-1M-V1-G</b>	Adapter cable G20 module/hand-held programming device
	<b>VAZ-G20-MH</b>	Mounting aid
	<b>VAZ-G10-LIMITER</b>	Voltage limiter G10
	<b>V311-GM-BK1M-PUR-U-V311-GM</b>	Cordset M8 socket straight to M8 plug straight B-coded, 5-pin, PUR cable black, UL-approved, drag chain suitable, torsion resistant
	<b>V311-GM-BK2M-PUR-U-V311-GM</b>	Cordset M8 socket straight to M8 plug straight B-coded, 5-pin, PUR cable black, UL-approved, drag chain suitable, torsion resistant