

Cable connector, Ethernet

V1SD-W-GN20M-PUR-E2S



- Hard-wearing PUR cable
- Industrial Ethernet
- D coding for Ethernet
- CAT5/CAT5e cable
- Degree of protection IP68 / IP69
- Free of paint wetting interfering substances
- UL listed for USA and Canada
- Halogen-free
- Specific design protects against loosening and inaccurate installation

Ethernet bus cable male cordset single-ended M12 angled D-coded 4-pin, PUR cable green, Cat5e, shielded, UL approved



Dimensions

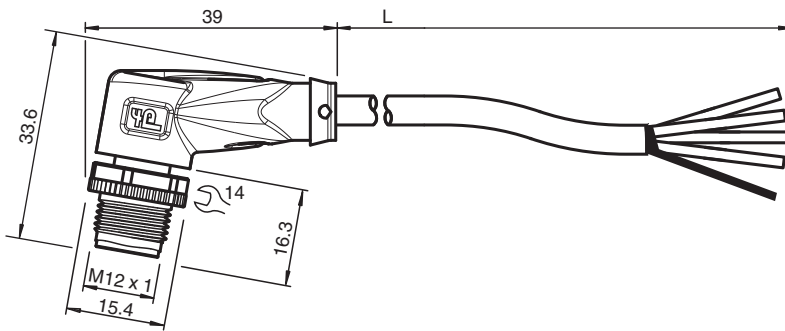

Technical Data

General specifications

Connector 1		
Connection		plug
Construction type		M12
Style		angled
Locking		screw connection
Number of pins		4
Coding		D-coded
Connector 2		
Connection		cable end

Electrical specifications

Operating voltage	U_B	max. 48 V AC / 60 V DC
Rated current	I_r	2 A

Conformity

Degree of protection		EN 60529
Fieldbus standard		Ethernet 100 Mbit/s

Release date: 2023-05-04 Date of issue: 2023-05-04 Filename: 70164942_eng.pdf

Refer to "General Notes Relating to Pepperl+Fuchs Product Information".

Pepperl+Fuchs Group
www.pepperl-fuchs.com

USA: +1 330 486 0001
fa-info@us.pepperl-fuchs.com

Germany: +49 621 776 1111
fa-info@de.pepperl-fuchs.com

Singapore: +65 6779 9091
fa-info@sg.pepperl-fuchs.com

PF PEPPERL+FUCHS

Technical Data

Plug connection		connector M12 x 1 : IEC 61076-2-101
Component category		CAT5 (IEC 11801) , CAT5e (IEC 61156-6)
Flammability		IEC 60332-1-2 / UL 1581 FT1
Halogen-free		IEC 60754-1
Chemical resistance		DIN EN 60811-2-1
Microbial resistance		DIN EN 50525-2-21 / DIN VDE 0282-10
Oil resistance		DIN EN 60811-2-1
Approvals and certificates		
UL approval		AWM STYLE 21161 AWM I/II A/B 80°C 300V FT1 (cable)
UL File Number		E231213
Ambient conditions		
Ambient temperature		
Plug connector		-40 ... 90 °C (-40 ... 194 °F)
Cable, fixed		-40 ... 80 °C (-40 ... 176 °F)
Cable, flexing		-30 ... 70 °C (-22 ... 158 °F)
Mechanical specifications		
Plug connector		
Tightening torque		0.6 Nm
Loosening protection		available
Tool installation		straight knurling and hexagon nut SW = 14 mm
Mating cycles		min. 100
Shielding		shield connected to screw connection
Degree of protection		IP68 / IP69
Cable		according to IEC/EN 60228 (DIN VDE 0295) class 5
Sheath diameter		4.8 mm
Bending radius		> 12 x cable diameter, moving > 6 x cable diameter, fixed
Sheath stripping force		max. 50 N / 100 mm
Sheath color		green (similar to RAL 6018)
Number of cores		4
Core cross section		0.15 mm ² / 26 AWG
Cores color		Core 1: white/orange Core 2: white/green Core 3: orange Core 4: green
Core construction		19 x 0.1 mm Ø twisted quad
Shield		aluminum-lined polyester foil Tinned copper braiding, 85 % coverage
Length	L	20 m
Cable code		Li 9Y 11YM 4 x 0,15
Drag chain suitability		
Motion velocity		max. 3 m/s
Acceleration		max. 3 m/s ²
Material		
PWIS free		yes
Halogen-free		yes
Plug connector		
Screw connection		Zinc diecast, nickel-plated
Body		TPU, black
Contact surface		Au
Flammability		V-2
Cable		
Sheathing		PUR based on polyether
Core insulation		PP

Release date: 2023-05-04 Date of issue: 2023-05-04 Filename: 70164942_eng.pdf

Refer to "General Notes Relating to Pepperl+Fuchs Product Information".

Pepperl+Fuchs Group
www.pepperl-fuchs.comUSA: +1 330 486 0001
fa-info@us.pepperl-fuchs.comGermany: +49 621 776 1111
fa-info@de.pepperl-fuchs.comSingapore: +65 6779 9091
fa-info@sg.pepperl-fuchs.com

PEPPERL+FUCHS

Technical Data





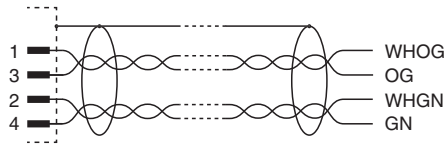
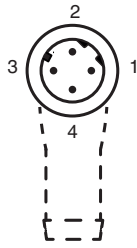

Flammability

FT1

Connection Assignment



Accessories

	MH V1-SCREWDRIVER	Torque screwdriver (0.6 Nm)
	MH V1-BIT M12	plug-in cap M12
	V1/V3-LABELHOLDER	Label holder
	V1/V3-LABEL	Label plate
	MH V1-Holder	Modular universal holder for M12 connectors
	V1-CLIP	Unlocking protector for M12 connector
	V1-MARKING-RING-COLOR	Marking rings for M12 connectors, various colors