



Triangulation sensor (BGS) OBT80-R2-E0-0,2M-V31-P



- High-performance miniature photoelectric sensors
- 45° cable outlet for maximum mounting freedom under extremely tight space constraints
- Highly visible light spot, even on dark materials
- Precision object detection, almost irrespective of the color
- Extremely long detection range paves the way for new applications

Triangulation sensor with background suppression for standard applications, miniature design, 80 mm sensing range, red light, light on, NPN output, 200 mm fixed cable with plug M8, 4-pin



Function

The nano sensor has been developed for a broad range of applications. It offers excellent durability and is exceptionally easy to install. The housing is compact and, with its 45° cable outlet, can be installed in the smallest spaces. New functional principles and functionality open up a range of new options.

Dimensions

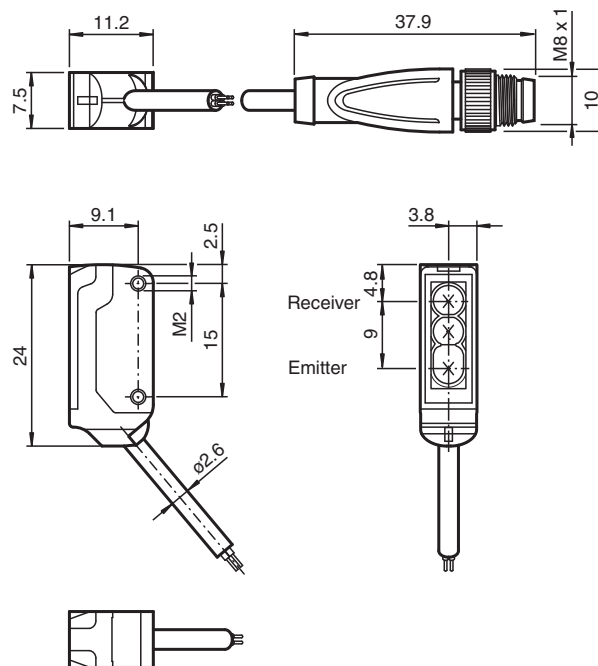

Technical Data

General specifications

| | |
|------------------|--------------------------------------|
| Detection range | 15 ... 80 mm |
| Reference target | standard black, 100 mm x 100 mm |
| Light source | LED |
| Light type | modulated visible red light , 630 nm |

Release date: 2023-03-28 Date of issue: 2023-03-28 Filename: 70141919_eng.pdf

Refer to "General Notes Relating to Pepperl+Fuchs Product Information".

Pepperl+Fuchs Group
www.pepperl-fuchs.com

USA: +1 330 486 0001
fa-info@us.pepperl-fuchs.com

Germany: +49 621 776 1111
fa-info@de.pepperl-fuchs.com

Singapore: +65 6779 9091
fa-info@sg.pepperl-fuchs.com

PF PEPPERL+FUCHS

Technical Data

| | | |
|---|----------------|--|
| Black-white difference (6 %/90 %) | | < 20 % |
| Angle deviation | | approx. 2 ° |
| Diameter of the light spot | | approx. 5 mm at a distance of 80 mm |
| Opening angle | | approx. 2 ° |
| Optical face | | frontal |
| Ambient light limit | | EN 60947-5-2 : 30000 Lux |
| Functional safety related parameters | | |
| MTTF _d | | 800 a |
| Mission Time (T _M) | | 20 a |
| Diagnostic Coverage (DC) | | 0 % |
| Indicators/operating means | | |
| Operation indicator | | LED green, statically lit Power on , short-circuit : LED green flashing (approx. 4 Hz) |
| Function indicator | | LED yellow ON: lights when object is detected |
| Electrical specifications | | |
| Operating voltage | U _B | 10 ... 30 V DC , class 2 |
| No-load supply current | I ₀ | < 10 mA |
| Protection class | | III |
| Output | | |
| Switching type | | NO contact / light-on |
| Signal output | | 1 NPN output, short-circuit protected, reverse polarity protected, open collector |
| Switching voltage | | max. 30 V DC |
| Switching current | | max. 50 mA , resistive load |
| Voltage drop | U _d | ≤ 1.5 V DC |
| Switching frequency | f | approx. 800 Hz |
| Response time | | 600 μs |
| Conformity | | |
| Product standard | | EN 60947-5-2 |
| Approvals and certificates | | |
| UL approval | | E87056 , cULus Recognized, Class 2 Power Source |
| CCC approval | | CCC approval / marking not required for products rated ≤36 V |
| Ambient conditions | | |
| Ambient temperature | | -25 ... 60 °C (-13 ... 140 °F) |
| Storage temperature | | -30 ... 70 °C (-22 ... 158 °F) |
| Mechanical specifications | | |
| Housing width | | 7.5 mm |
| Housing height | | 24 mm |
| Housing depth | | 11.2 mm |
| Degree of protection | | IP67 |
| Connection | | 200 mm fixed cable with 4-pin, M8x1 connector |
| Material | | |
| Housing | | PC/ABS and TPU |
| Optical face | | PC |
| Cable | | PUR |
| Installation | | Fixing screws , 2 x M2 allen head screws included with delivery |
| Mass | | approx. 20 g |
| Cable length | | 200 mm |

Release date: 2023-03-28 Date of issue: 2023-03-28 Filename: 70141919_eng.pdf

Refer to "General Notes Relating to Pepperl+Fuchs Product Information".

Pepperl+Fuchs Group
www.pepperl-fuchs.comUSA: +1 330 486 0001
fa-info@us.pepperl-fuchs.comGermany: +49 621 776 1111
fa-info@de.pepperl-fuchs.comSingapore: +65 6779 9091
fa-info@sg.pepperl-fuchs.com

PEPPERL+FUCHS

Connection

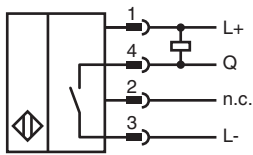

Connection Assignment



Wire colors in accordance with EN 60947-5-2

| | | |
|---|----|---------|
| 1 | BN | (brown) |
| 2 | WH | (white) |
| 3 | BU | (blue) |
| 4 | BK | (black) |

Assembly

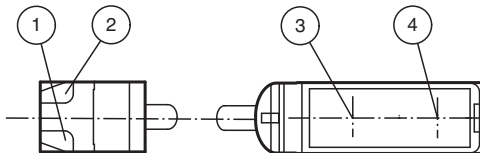

| | | |
|---|-------------------|--------|
| 1 | Operating display | green |
| 2 | Signal display | yellow |
| 3 | Emitter | |
| 4 | Receiver | |

Characteristic Curve

Characteristic response curve

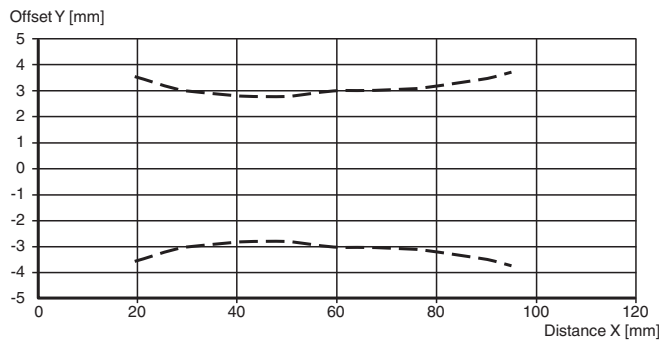

Release date: 2023-03-28 Date of issue: 2023-03-28 Filename: 70141919_eng.pdf

Refer to "General Notes Relating to Pepperl+Fuchs Product Information".

Pepperl+Fuchs Group
www.pepperl-fuchs.com

USA: +1 330 486 0001
fa-info@us.pepperl-fuchs.com

Germany: +49 621 776 1111
fa-info@de.pepperl-fuchs.com





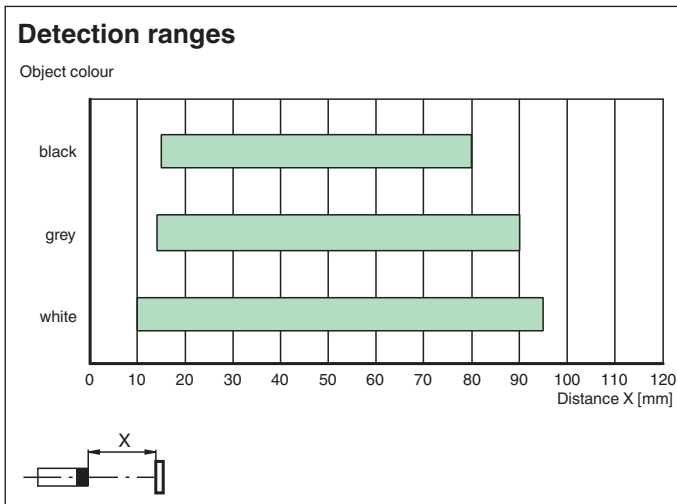

Singapore: +65 6779 9091
fa-info@sg.pepperl-fuchs.com

PF PEPPERL+FUCHS

Characteristic Curve



Accessories

| | | |
|---|----------------------|--|
|  | MH-R2-01 | Mounting aid for R2 series, Mounting bracket |
|  | MH-R2-02 | Mounting aid for R2 series, Mounting bracket |
|  | MH-R2-03 | Mounting aid for R2 series, Mounting bracket |
|  | MH-R2-04 | Mounting aid for R2 series, Mounting bracket |
|  | V31-GM-2M-PUR | Female cordset single-ended M8 straight A-coded, 4-pin, PUR cable grey |
|  | V31-WM-2M-PUR | Female cordset single-ended M8 angled A-coded, 4-pin, PUR cable grey |