



# Photoelectric slot sensor GL3-T/153



- Miniature design
- Optimized for the detection of small parts
- High switching frequency

Miniature photoelectric slot sensor for the detection of small parts, T-shaped housing design, 3.15 mm slot width, infrared light, NPN outputs, fixed cable



## Function

The GL2 & GL3 miniature slot sensor is the smallest slot sensor in its family optimized to the requirements in semiconductors industry for small part detection. A wide voltage range of 5 V DC ... 30 V DC and a extreme fast response time of 25  $\mu$ s stands for the quality of this sensor. The GL2 & GL3 sensor can be directly connected to a comparator or Schmitt-trigger circuit. Due to a variety of different housings and an optimized housing concept offers the sensor a maximum of freedom in a crowded mounting environment.

## Dimensions

1	collector
2	emitter
3	anode
4	cathode

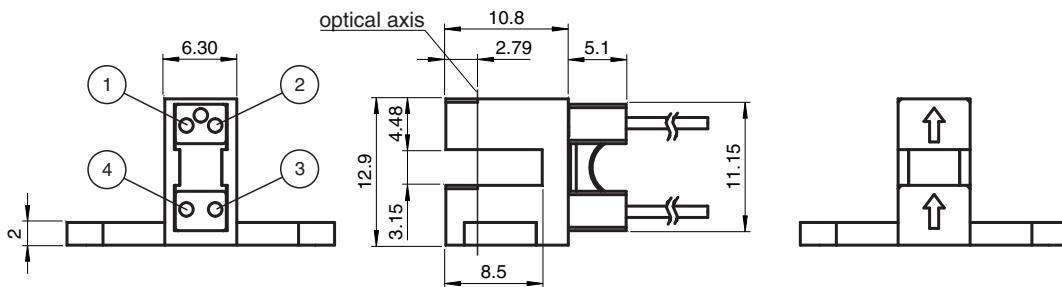
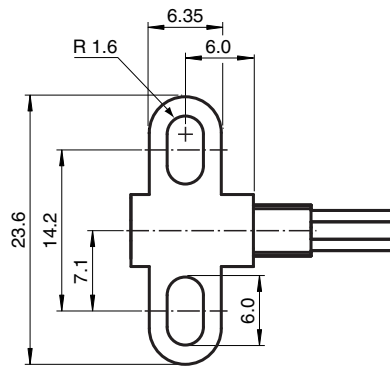

Release date: 2022-08-08 Date of issue: 2022-08-08 Filename: 802746\_eng.pdf

Refer to "General Notes Relating to Pepperl+Fuchs Product Information".

Pepperl+Fuchs Group  
www.pepperl-fuchs.com

USA: +1 330 486 0001  
fa-info@us.pepperl-fuchs.com

Germany: +49 621 776 1111  
fa-info@de.pepperl-fuchs.com

Singapore: +65 6779 9091  
fa-info@sg.pepperl-fuchs.com

**PF** PEPPERL+FUCHS

## Technical Data

General specifications		
Light source		IRET , 940 nm
Light type		IRET
Slot width		3.15 mm
Slot depth		3.15 mm
Ambient light limit		1000 Lux
Electrical specifications		
Operating voltage	$U_B$	5 ... 30 V DC
Ripple		10 %
Emitter		
Light type		940 nm IR light
Forward voltage	$V_F$	< 1.6 V
Peak forward voltage	$V_{FM}$	30 V
Forward current	$I_F$	50 mA
Pulse current	$I_{FM}$	1 A
Reverse voltage	$V_R$	5 V
Reverse current	$I_R$	≤ 10 μA
Power dissipation		75 mW
Receiver		
Output type		NPN
C-E breakdown voltage	$V_{CEO}$	30 V
E-C breakdown voltage	$V_{ECO}$	5 V
Collector dark current	$I_{CEO}$	< 1 μA
Collector DC current	$I_C$	20 mA
Power dissipation	$P_D$	75 mW
Output		
Signal output		1 NPN , photo transistor
Switching voltage		max. 30 V DC
Switching current		20 mA
Response time		25 μs
Approvals and certificates		
EAC conformity		TR CU 020/2011
CCC approval		CCC approval / marking not required for products rated ≤36 V
Ambient conditions		
Ambient temperature		-20 ... 85 °C (-4 ... 185 °F)
Storage temperature		-40 ... 85 °C (-40 ... 185 °F)
Mechanical specifications		
Core cross section		4 x 0.08 mm <sup>2</sup>
Housing width		23.6 mm
Housing height		12.9 mm
Housing depth		15.9 mm
Degree of protection		IP30
Connection		610 mm, PVC cable , Individual colored wires
Material		
Housing		PC
Mass		7 g

Release date: 2022-08-08 Date of issue: 2022-08-08 Filename: 802746\_eng.pdf

Refer to "General Notes Relating to Pepperl+Fuchs Product Information".

Pepperl+Fuchs Group  
www.pepperl-fuchs.comUSA: +1 330 486 0001  
fa-info@us.pepperl-fuchs.comGermany: +49 621 776 1111  
fa-info@de.pepperl-fuchs.comSingapore: +65 6779 9091  
fa-info@sg.pepperl-fuchs.com

**PEPPERL+FUCHS**

**Connection Assignment**

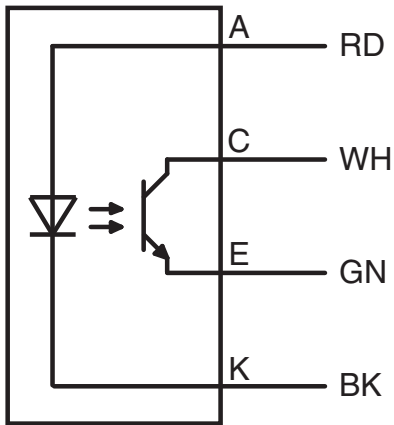

**Characteristic Curve**

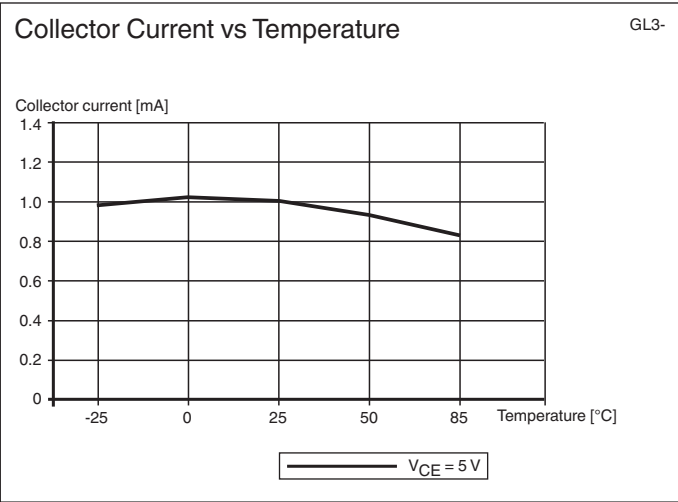
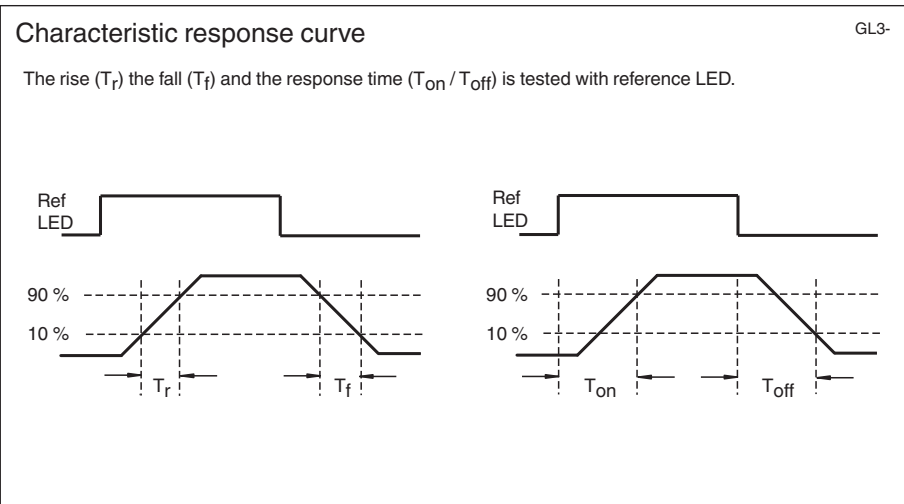

Release date: 2022-08-08 Date of issue: 2022-08-08 Filename: 802746\_eng.pdf

Characteristic Curve

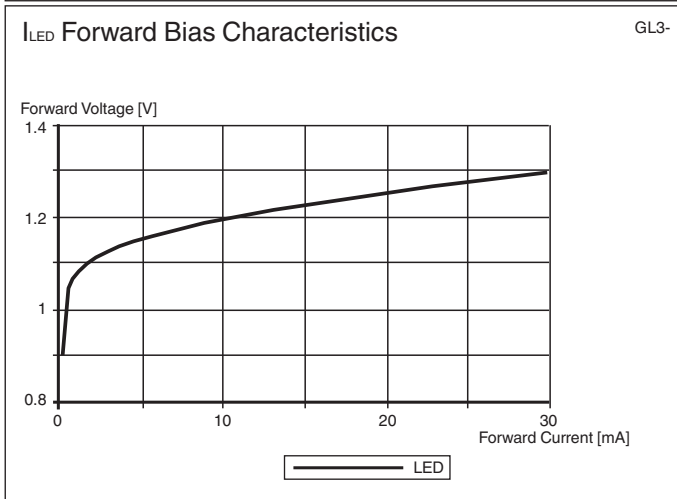
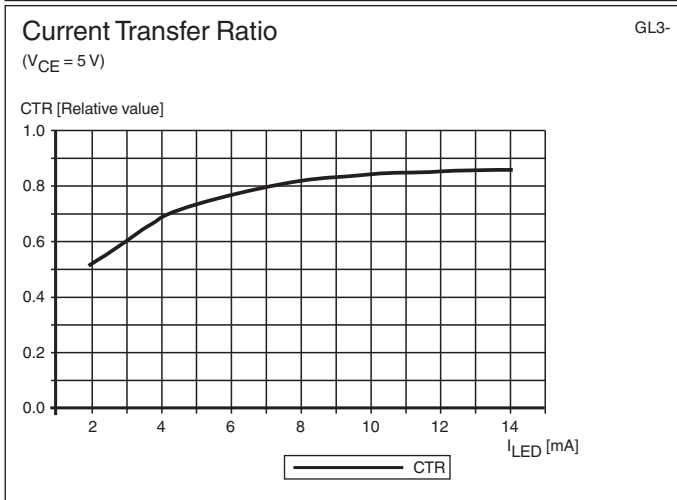
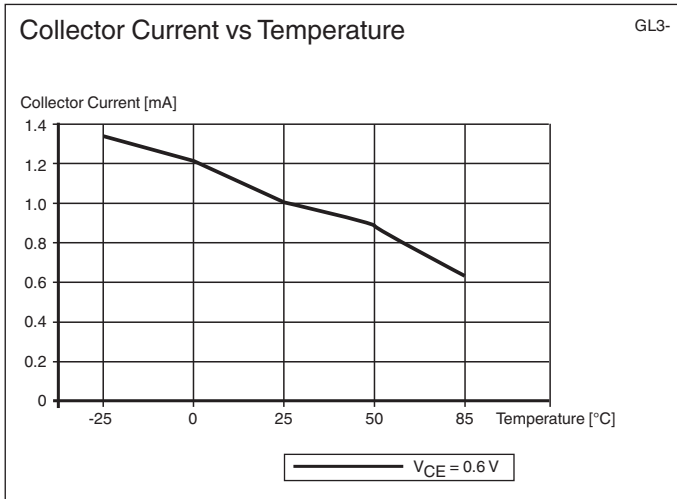

Release date: 2022-08-08 Date of issue: 2022-08-08 Filename: 802746\_eng.pdf

Characteristic Curve

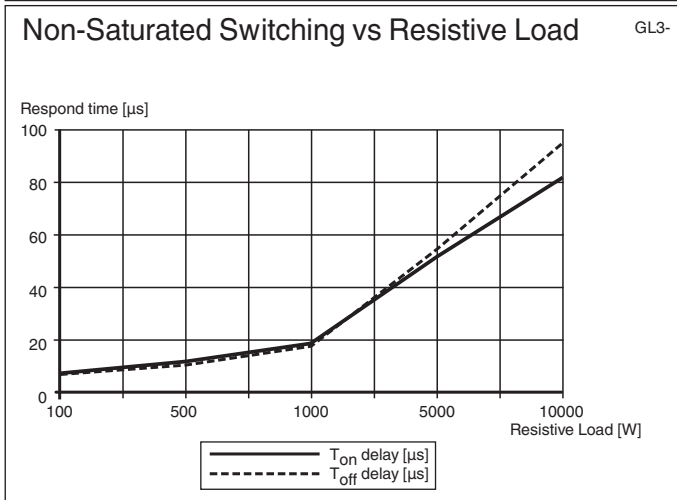
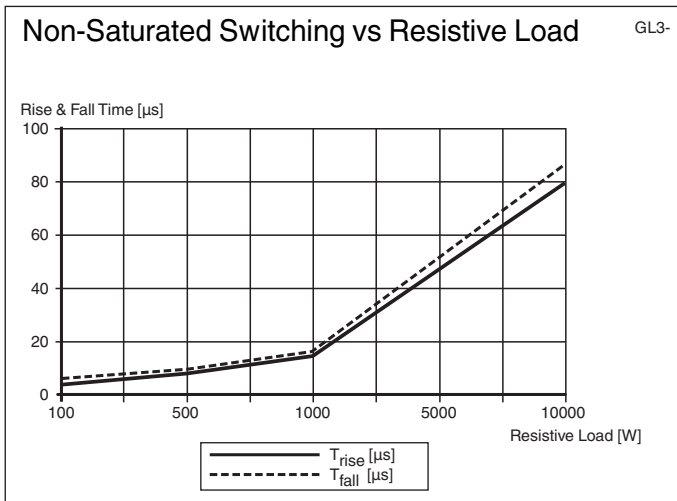

Release date: 2022-08-08 Date of issue: 2022-08-08 Filename: 802746\_eng.pdf

**Connection example**

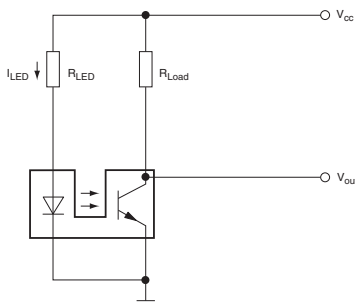

**3 simple steps:**

- Choose power supply
- Choose LED current (set resistor  $R_{LED}$ )
- Choose load current (set resistor  $R_{LOAD}$ )

**Possible connections**

<p>Circuit with voltage comparator</p>	<p>Circuit with additional transistor</p>
<p>Circuit with Op Amp</p>	<p>Circuit with PNP transistor output</p>

Release date: 2022-08-08 Date of issue: 2022-08-08 Filename: 802746\_eng.pdf