

Cable socket, shielded

V1-W-10M-PVC-ABG

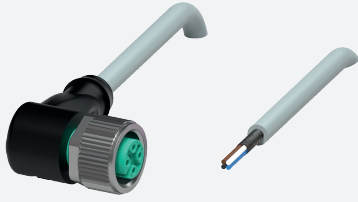

- Degree of protection IP68 / IP69
- Shield connected to screw connection
- Specific design protects against loosening and inaccurate installation

Female cordset single-ended M12 angled A-coded, 4-pin, PVC cable grey, shielded



Dimensions

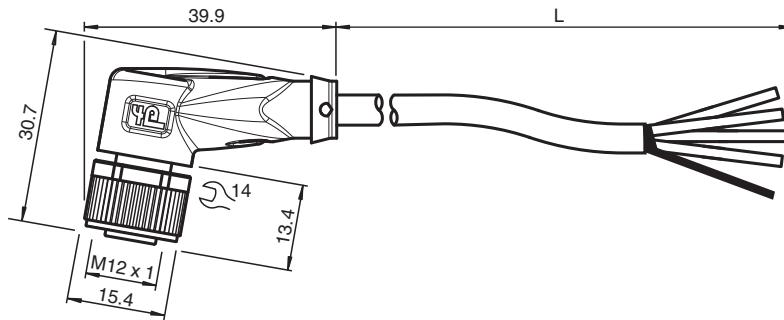

Technical Data

General specifications

| | |
|--------------------|------------------|
| Connector 1 | |
| Connection | socket |
| Construction type | M12 |
| Style | angled |
| Locking | screw connection |
| Number of pins | 4 |
| Coding | A-coded |
| Connector 2 | |
| Connection | cable end |

Electrical specifications

| | | |
|-------------------|-------|------------------------|
| Operating voltage | U_B | max. 48 V AC / 60 V DC |
| Operating current | I_B | max. 4 A |

Conformity

| | |
|----------------------|-------------------------------------|
| Degree of protection | EN 60529 |
| Plug connection | connector M12 x 1 : IEC 61076-2-101 |
| Flammability | IEC 60332-2-2 |

Ambient conditions

| | |
|----------------------------|--------------------------------|
| Ambient temperature | |
| Plug connector | -40 ... 90 °C (-40 ... 194 °F) |
| Cable, fixed | -30 ... 80 °C (-22 ... 176 °F) |

Release date: 2023-08-23 Date of issue: 2023-08-23 Filename: 240005-100014_eng.pdf

Refer to "General Notes Relating to Pepperl+Fuchs Product Information".

Pepperl+Fuchs Group
www.pepperl-fuchs.com

USA: +1 330 486 0001
fa-info@us.pepperl-fuchs.com

Germany: +49 621 776 1111
fa-info@de.pepperl-fuchs.com

Singapore: +65 6779 9091
fa-info@sg.pepperl-fuchs.com

PEPPERL+FUCHS

Technical Data

| | |
|----------------------------------|---|
| Cable, flexing | -15 ... 80 °C (5 ... 176 °F) |
| Pollution degree | 3 |
| Mechanical specifications | |
| Plug connector | |
| Tightening torque | 0.6 Nm |
| Loosening protection | available |
| Tool installation | straight knurling and hexagon nut SW = 14 mm |
| Mating cycles | min. 100 |
| Shielding | shield connected to screw connection |
| Degree of protection | IP68 / IP69 |
| Cable | according to IEC/EN 60228 (DIN VDE 0295) class 5 |
| Sheath diameter | 4.8 mm |
| Bending radius | > 10 x cable diameter, moving > 5 x cable diameter, fixed |
| Sheath stripping force | max. 25 N / 100 mm |
| Sheath color | grey (similar to RAL 7001) |
| Number of cores | 4 |
| Core cross section | 0.34 mm ² |
| Cores color | Core 1: brown Core 2: white Core 3: blue Core 4: black |
| Core construction | 19 x 0.15 mm Ø |
| Shield | tinned copper braiding, 85 % coverage |
| Length | L 10 m |
| Cable code | Li 9Y YM 4 x 0,34 |
| Material | |
| Plug connector | |
| Screw connection | Zinc diecast, nickel-plated |
| Body | TPU, black |
| Seal | FKM |
| Contact surface | gold plated (Au) |
| Flammability | V-2 |
| Cable | |
| Sheathing | PVC |
| Core insulation | PP |
| Flammability | flame-resistant |



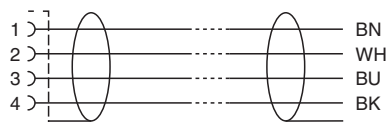
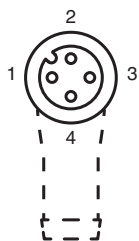



Connection



Accessories

| | | |
|---|--------------------------|-----------------------------|
|  | MH V1-SCREWDRIVER | Torque screwdriver (0.6 Nm) |
|---|--------------------------|-----------------------------|

Accessories

| | | |
|---|------------------------------|--|
|  | MH V1-BIT M12 | plug-in cap M12 |
|  | V1/V3-LABELHOLDER | Label holder |
|  | V1/V3-LABEL | Label plate |
|  | MH V1-Holder | Modular universal holder for M12 connectors |
|  | V1-CLIP | Unlocking protector for M12 connector |
|  | V1-MARKING-RING-COLOR | Marking rings for M12 connectors, various colors |