

Print mark color sensor

DF12-11-3K/9s20/145/151



- Diffuse mode sensor for recording colored print marks on backgrounds with different colors
- Color detection by means of the active three-range method
- TEACH-IN procedure for automatic threshold value setting
- 3 independent channels
- 3 tolerance steps per channel
- 3 Push-pull outputs

Print mark color sensor, 11 mm detection range, RGB light, external Teach-In, timer function, 3 push-pull outputs, M12 plug



Dimensions

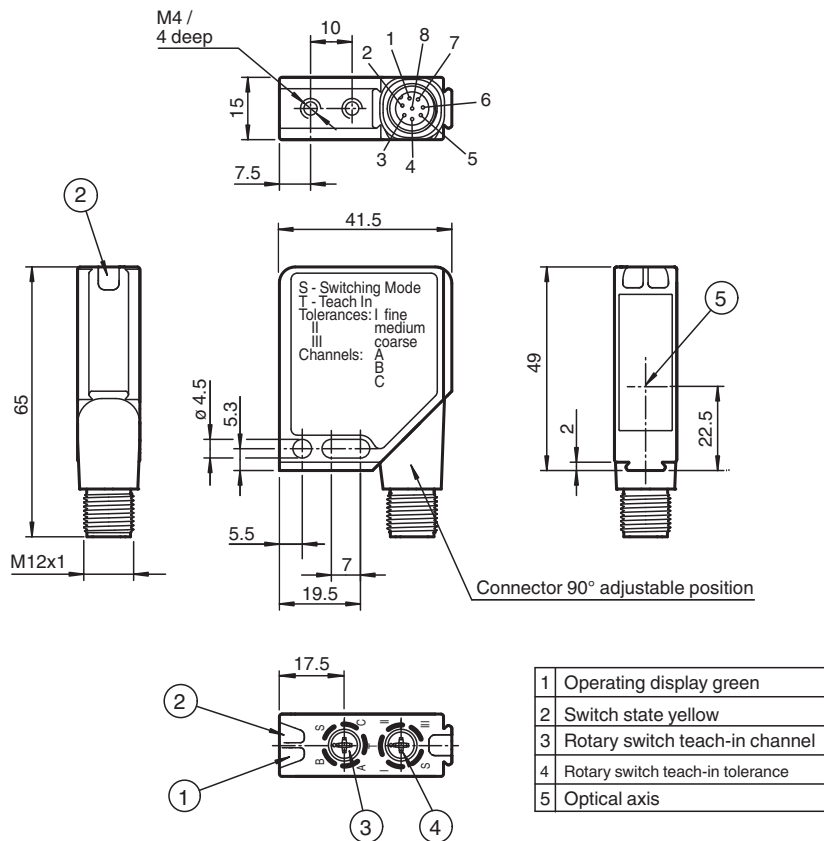

Technical Data

General specifications

Sensor range 11 mm ± 2 mm

Release date: 2022-02-07 Date of issue: 2022-02-07 Filename: 132619_eng.pdf

Refer to "General Notes Relating to Pepperl+Fuchs Product Information".

Pepperl+Fuchs Group
www.pepperl-fuchs.com

USA: +1 330 486 0001
fa-info@us.pepperl-fuchs.com

Germany: +49 621 776 1111
fa-info@de.pepperl-fuchs.com

Singapore: +65 6779 9091
fa-info@sg.pepperl-fuchs.com

PF PEPPERL+FUCHS

Technical Data

Light source		3 LEDs (R,G,B)
Light type		Visible green/red/blue, modulated light
Light spot representation		1 mm x 3 mm
Angle deviation		max. $\pm 3^\circ$
Functional safety related parameters		
MTTF _d		730 a
Mission Time (T _M)		20 a
Diagnostic Coverage (DC)		60 %
Indicators/operating means		
Operation indicator		LED green, statically lit Power on , Undervoltage indicator: Green LED, pulsing (approx. 0.8 Hz) , short-circuit : LED green flashing (approx. 4 Hz)
Function indicator		2 LEDs yellow, light up in case of detection
Teach-In indicator		Teach-In channel: LED green/yellow equiphase flashing; 2.5 Hz . Teach-In tolerance: LED green/yellow non equiphase flashing; 2.5 Hz .
Control elements		2 Teach-In rotary switch for Teach-In channel and Teach-In tolerance .
Electrical specifications		
Operating voltage	U _B	10 ... 30 V DC
Ripple		10 %
No-load supply current	I ₀	≤ 40 mA
Protection class		II, rated voltage ≤ 250 V AC with pollution degree 1-2 according to IEC 60664-1
Input		
Function input		Ext. Teach-In input (ET) Ext. blanking-input (AT)
Output		
Signal output		3 push-pull (4 in 1) outputs, short-circuit proof, reverse polarity protected
Switching voltage		max. 30 V DC
Switching current		max. 100 mA
Switching frequency	f	500 Hz
Response time		1 ms
Timer function		Impulsed time element off-delay 20 ms
Conformity		
Product standard		EN 60947-5-2
Approvals and certificates		
EAC conformity		TR CU 020/2011
CCC approval		CCC approval / marking not required for products rated ≤36 V
Approvals		CE, cULus
Ambient conditions		
Ambient temperature		-20 ... 60 °C (-4 ... 140 °F)
Storage temperature		-20 ... 75 °C (-4 ... 167 °F)
Mechanical specifications		
Housing width		41.5 mm
Housing height		49 mm
Housing depth		15 mm
Degree of protection		IP67
Connection		8-pin, M12 metal connector, 90° convertible
Material		
Housing		Frame: nickel plated, die cast zinc, Laterals: glass-fiber reinforced plastic PC
Optical face		Plastic pane
Mass		60 g
Note		(use V19 type connection cable)

Connection Assignment

Option

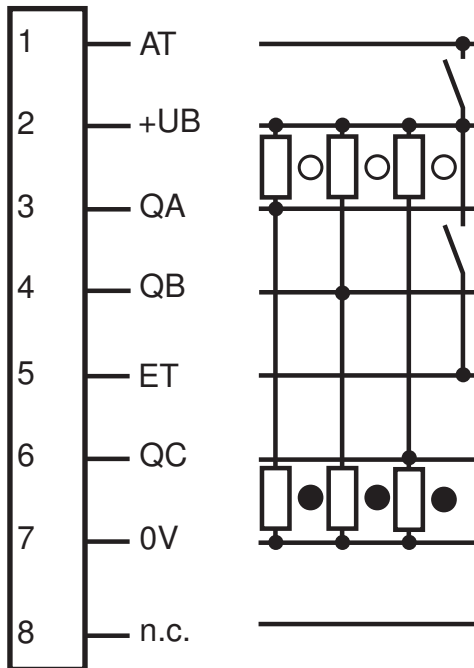

○ = Background
● = Mark

Connection Assignment

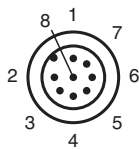

Wire colors



1	WH	(white)
2	BN	(brown)
3	GN	(green)
4	YE	(yellow)
5	GY	(gray)
6	PK	(pink)
7	BU	(blue)
8	RD	(red)

Release date: 2022-02-07 Date of issue: 2022-02-07 Filename: 132619_eng.pdf

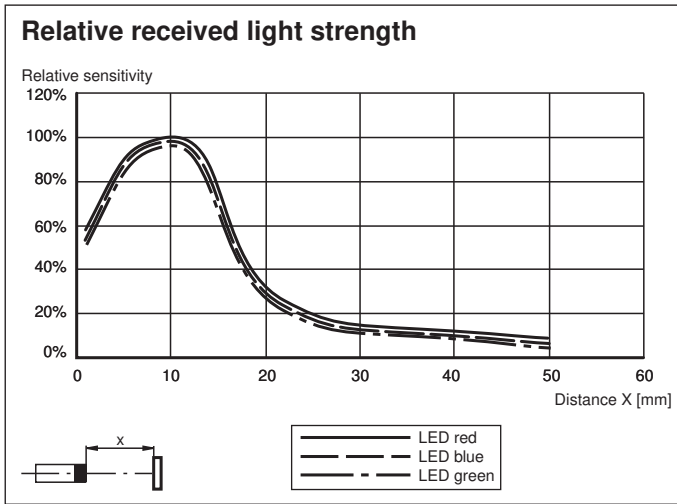
Refer to "General Notes Relating to Pepperl+Fuchs Product Information".



Accessories

	V19-G-5M-PVC	Female cordset, M12, 8-pin, PVC cable
	V19-G-2M-PUR-ABG	Female cordset single-ended M12 straight A-coded, 8-pin, PUR cable grey, shielded

Release date: 2022-02-07 Date of issue: 2022-02-07 Filename: 132619_eng.pdf

Additional Information

Adjustment

For each of the three output channels, a different colour can be taught in with the desired tolerance. In the case of reflecting or shiny objects, the sensor must be tilted by approx. 10° against the material surface.

Operating modes:

TEACH-IN channel: Teaching in a colour with tolerance on a selected output channel.

TEACH-IN tolerance: Changing the tolerance of a colour that has already been taught in on a channel.

Switching mode:

The green indicator LED lights statically, the yellow indicator LED lights if at least one of the three channels detects its taught-in colour. The switching outputs switch PNP if they detect their taught-in colour and NPN if they do not detect a colour.

TEACH-IN via rotary switch

Each change of the switch position must pass a time lock of approx. 1.5 s before the sensor accepts the desired setting.

That means that the switch must constantly remain in the desired position for 1.5 s.

Once the time lock has been passed, the indicator LEDs change their flashing function.

TEACH-IN channel (colour teach-in)

1. Set channel selector switch to **T** position.
Once the time lock has been passed, the sensor changes to the following mode: **TEACH-IN channel**. Green and yellow LEDs flash in an equiphase manner with approx. 2.5Hz. All switching outputs are deactivated.
2. Position the light spot completely and permanently on the mark to be detected.
3. Set the desired tolerance via the tolerance selector switch.
Position **I**: fine
Position **II**: average
Position **III**: coarse
4. Use the channel selector switch to select the channel which is to indicate the detection of this colour.
Position **A**: channel Q_A
Position **B**: channel Q_B
Position **C**: channel Q_C
After the time lock has been passed, the colour is taught in with the selected tolerance, assigned to the selected channel and the setting is saved in a non-volatile manner. The sensor changes to **switching mode**.
5. Set both selector switches to **S** position.

TEACH-IN tolerance (tolerance relearning)

1. Set the tolerance selector switch to **T** position.
Once the time lock has been passed, the sensor changes to the following mode: **TEACH-IN tolerance**. Green and yellow LEDs flash in an antiphase manner with approx. 2.5Hz. Emitters and all switching outputs are deactivated.
2. Use the channel selector switch to select the desired channel.
Position **A**: channel Q_A
Position **B**: channel Q_B
Position **C**: channel Q_C
3. Use the tolerance selector switch to set the new tolerance level for the selected channel.
Position **I**: fine
Position **II**: medium
Position **III**: coarse
After the time lock has been passed, the set tolerance level is assigned to the channel and saved in a non-volatile manner. The sensor changes to **switching mode**.

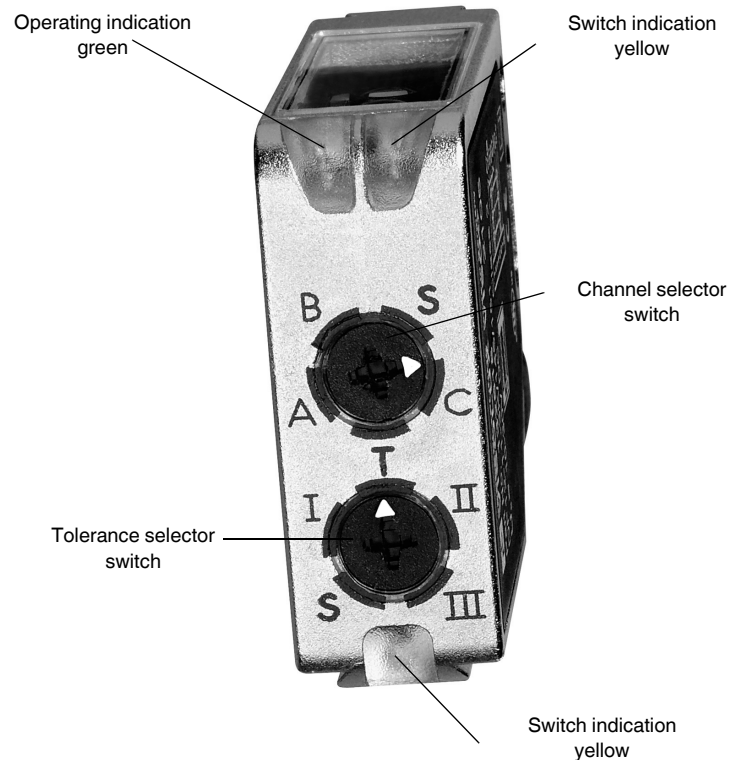

Release date: 2022-02-07 Date of issue: 2022-02-07 Filename: 132619_eng.pdf

- Set both selector switches to **S** position.

Teach-In via External Teach-In input

The sensor channel and tolerance level can be taught in via the External Teach-In input (ET). For this purpose, positive pulses of a different duration must be created on the ET:

120 ... 150 ms	Teach-In channel A
220 ... 250 ms	Teach-In channel B
320 ... 350 ms	Teach-In channel C
420 ... 450 ms	Teach-In tolerance level I (fine)
520 ... 550 ms	Teach-In tolerance level II (medium)
620 ... 650 ms	Teach-In tolerance level III (coarse)

Teach-In channel

- Create a positive pulse (*duration according to desired sensor channel A, B or C*) on the External Teach-In input (ET).
The sensor changes to the **Teach-In channel** mode.
The green and the yellow indicator LEDs start to flash in an equiphase manner ($f = 2.5$ Hz), the switching outputs are deactivated, both rotary switches are switched off.
- Position the colour to be taught in permanently in the light spot. During this process, the light spot must be completely positioned on the colour to be taught in.
- Create a positive pulse (duration according to desired tolerance level I, II or III) on External Teach-In input (ET).
The desired colour is taught in by the sensor and assigned to the selected channel with the appropriate tolerance level and saved in a non-volatile manner.
The sensor changes back to the **switching mode**, i.e. the green indicator LED lights statically, the yellow indicator LED lights if at least one colour channel has detected its taught-in colour.
The switching outputs each switch according to their taught-in colour (PNP= colour of the corresponding channel detected, NPN= colour of the corresponding channel not detected).

TEACH-IN tolerance

- Create a positive pulse (*duration according to desired tolerance level I, II or III*) on External Teach-In input (ET).
The sensor changes to the **Teach-In tolerance** mode.
The green and the yellow indicator LEDs start to flash in an antiphase manner ($f = 2.5$ Hz), emitters and switching outputs are deactivated, both rotary switches are switched off.
- Create a positive pulse (duration according to desired sensor channel A, B or C) on the External Teach-In input (ET).
The desired tolerance level is assigned to the selected channel by the sensor and saved in a non-volatile manner.
The sensor changes back to the switching mode, i.e. the green indicator LED lights statically, the yellow indicator LED lights if at least one colour channel has detected its taught-in colour.
The switching outputs each switch according to their taught-in colour (PNP= colour of the corresponding channel detected, NPN= colour of the corresponding channel not detected).

Blanking input

All of the switching outputs are deactivated for the duration of a positive signal on the External Blanking input (AT).

Failures

The Teach-In modes are switched off for the duration of the below-mentioned failures.

In the case of a failure during active Teach-In mode, it is quit immediately and must be reselected after the failure has been eliminated.

Short circuit indication

If the current on at least one of the switching outputs is too high, all of the switching outputs are deactivated for the duration of the short circuit in order to avoid damage.

The short circuit is indicated to the user via the green indicator LED (flashing with $f = 4$ Hz).

Undervoltage indication

If the supply voltage falls below a critical value such that the sensor can no longer operate properly, all of the switching outputs are deactivated.

The undervoltage operation is indicated to the user via the green indicator LED (double flash with $f = 0.8$ Hz).

Any active Teach-In modes are quit and must be reselected after the failure has been eliminated.