

Dimensions

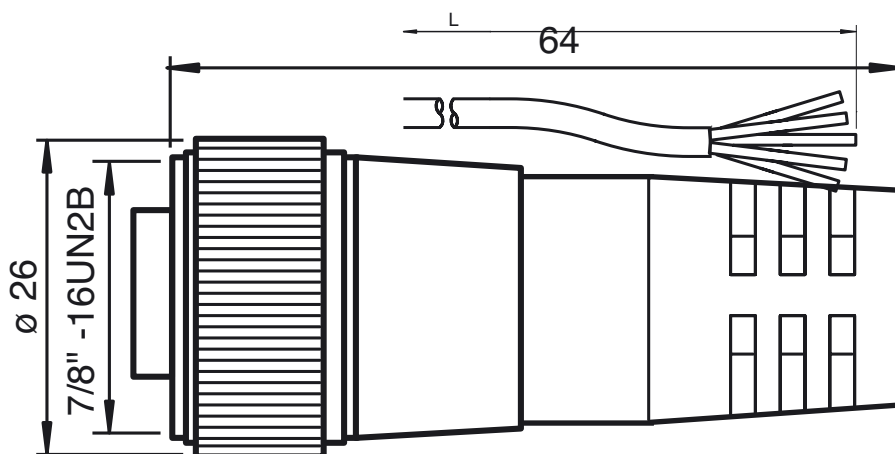

Model Number

V95-G-YE2M-PVC-22

Female cordset, 7/8" - 16 UNF, 5-pin, PVC cable

Features

- Thread 7/8 inch
- Immunity to vibration

Technical data

General specifications

Number of pins	5
Connection 1	socket
Construction type 1	straight
Threading 1	7/8 inch
Connection 2	cable end

Electrical specifications

Operating voltage	U_B	max. 300 V
Operating current	I_B	max. 4 A

Ambient conditions

Ambient temperature	-25 ... 105 °C (-13 ... 221 °F)
Pollution degree	3

Mechanical specifications

Degree of protection	IP68
Material	
Contacts	gold plated copper alloy
Body	PVC
Cable	PVC
Slotted nut	nickel-plated brass
Cable	fine-strand, flexible
Sheath diameter	Ø 5.7 mm
Color	yellow
Cores	5 x 0.34 mm ²
Length	L 2 m

Electrical connection

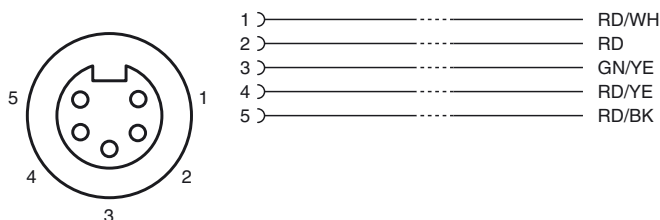

Release date: 2018-04-09 14:50 Date of issue: 2018-04-09 910360_eng.xml

Refer to "General Notes Relating to Pepperl+Fuchs Product Information".