



Operating instructions
Filter cover for pressure sensors

GB

E30483
E30142
E30148
E30139
E30467



Contents

1	Preliminary note	3
1.1	Symbols used	3
2	Safety instructions	4
3	Intended use	5
4	Installation	6
4.1	Optional filter covers	6
4.2	Removal of the existing filter cover	7
4.3	Installation of filter cover E30483 & E30142	7
4.4	Installation of filter cover E30148	7
4.5	Installation of filter cover E30139	8
4.6	Installation of filter cover E30467	8
4.6.1	Installation of the primary protective element	8
4.6.2	Installation of the secondary protective element	9
4.7	Orientation filter cover	9
5	Disposal and return	10

1 Preliminary note

You will find instructions, technical data, approvals and further information using the QR code on the unit / packaging or at www.ifm.com.

1.1 Symbols used

- ✓ Requirement
- ▶ Instructions
- ▷ Reaction, result
- [...] Designation of keys, buttons or indications
- Cross-reference
-  Important note
Non-compliance may result in malfunction or interference.
-  Information
Supplementary note

2 Safety instructions

- Read this document before setting up the product and keep it during the entire service life.
- The product must be suitable for the corresponding applications and environmental conditions without any restrictions.
- Only use the product for its intended purpose (→ Intended use).
- Only use the product for permissible media (→ Technical data).
- If the operating instructions or the technical data are not adhered to, personal injury and/or damage to property may occur.
- The manufacturer assumes no liability or warranty for any consequences caused by tampering with the product or incorrect use by the operator.
- Installation, set-up, operation and maintenance of the product must be carried out by qualified personnel authorised by the machine operator.
- Protect units, accessories and cables against damage.

3 Intended use

The different protective elements (filter covers) can be used for pressure sensors with screwed pressure compensation elements to avoid soiling of the ventilation diaphragm in harsh environments.

4 Installation



The illustrations are examples of pressure sensors with pressure compensation elements fitted. The housing design varies depending on the unit series.



Ensure that the sensor is not subjected to moisture during installation.

4.1 Optional filter covers

Overview of optional filter covers:

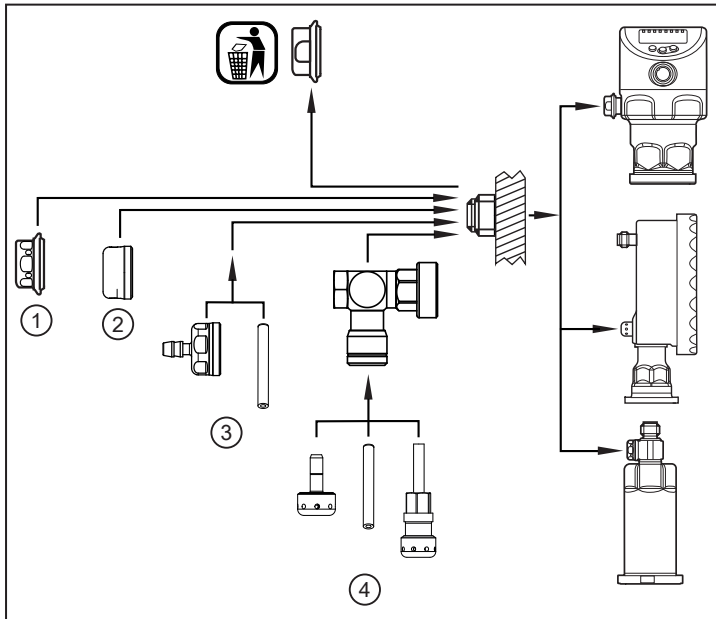

(1) Accessory E30483 (with drip edge) or E30142 (without drip edge)

Filter cover with integrated ventilation diaphragm.

See: Installation of filter cover E30483 & E30142 (→ □ 7)

(2) Accessory E30148

Closed version of the filter cover: → Observe the operating instructions of the sensor!

See: Installation of filter cover E30148 (→ □ 7)

(3) Set of accessories E30139

Filter cover with integrated ventilation diaphragm and tube fitting with a vent tube.

See: Installation of filter cover E30139 (→ □ 8)

(4) Set of accessories E30467

Ventilation for demanding applications:

Consisting of an adapter with integrated ventilation diaphragm, a tube fitting that is directly inserted into a right-angle fitting, or with a vent tube placed in between.

See: Installation of filter cover E30467 (→ □ 8)

4.2 Removal of the existing filter cover

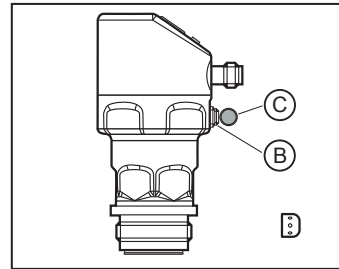
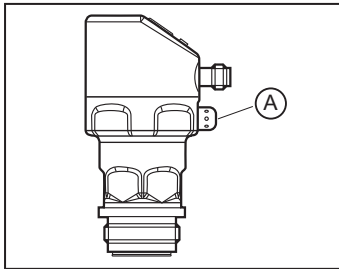

- ▶ Remove the filter cover (A) using an appropriate tool.
- ▶ Pull the ventilation diaphragm (C) off the base (B).
- ▷ The sensor is prepared for the installation of optional filter covers.

4.3 Installation of filter cover E30483 & E30142



Use a filter cover with the same design as the original part:
E30483 (with drip edge) or E30142 (without drip edge)

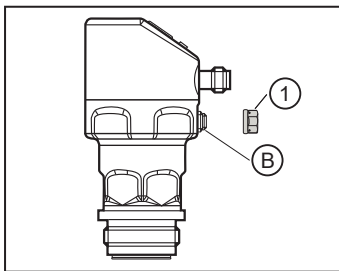

- ▶ Remove the filter cover. See: Removal of the existing filter cover (→ □ 7)
- ▶ Screw the filter cover with integrated ventilation diaphragm (1) onto the base (B) and tighten using a spanner, across flats 11. Tightening torque 2.5...3.5 Nm.
- ▶ Observe the orientation of the filter cover. See: Orientation filter cover (→ □ 9)

4.4 Installation of filter cover E30148

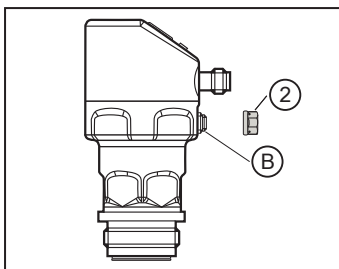

- ▶ Remove the filter cover. See: Removal of the existing filter cover (→ □ 7)
- ▶ Screw the closed filter cover (2) onto the base (B) and tighten using a spanner, across flats 11. Tightening torque 2.5...3.5 Nm.



- ▶ Please ensure that the application is suitable for use without the pressure compensation being active.
- ▶ When using the closed filter cover, please note:
 - ▷ The closed filter cover does not allow any pressure compensation of the relative pressure meter.
 - ▷ The internal pressure of the sensor changes by 35 mbar for every 10 K of temperature change.



The closed filter cover is recommended under the following conditions only:

Harsh environments.

Applications where decreased accuracy is accepted.

4.5 Installation of filter cover E30139

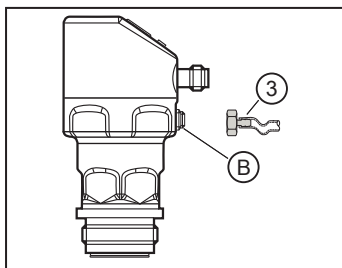

- ▶ Remove the filter cover. See: Removal of the existing filter cover (→ [7](#))
- ▶ Screw the filter cover (3) with integrated ventilation diaphragm onto the base (B) and tighten using a spanner, across flats 11. Tightening torque 2.5...3.5 Nm.
- ▶ Attach the tube (L = 0.5 m, internal diameter 3 mm, polyamide) onto the filter cover (3) and place the free end in a protected area.

4.6 Installation of filter cover E30467

Overview of the different components

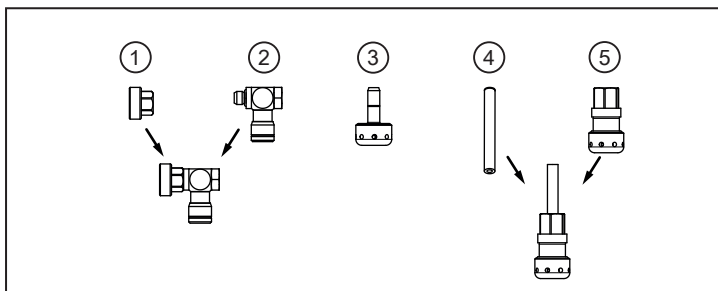

- 1: Adapter with integrated ventilation diaphragm
- 2: Tube connection
- 3: Plug-in element with integrated ventilation diaphragm
- 4: Vent tube
- 5: Plug-in element with integrated ventilation diaphragm

Mount the protective elements

Compared to the premounted filter cover the protective elements provide a better protection of the ventilation diaphragm against unfavourable environmental conditions.

These are for example: heavy soiling, excess condensate or high air humidity in case of a cold sensor surface in the ventilation diaphragm area.

You can select from a primary protective element with a ventilation diaphragm or a secondary protective element with two ventilation diaphragms.

For the tube version, the venting at the end of the tube can be positioned in a more protected area if necessary.

See tube version: Installation of the secondary protective element (→ [9](#))

4.6.1 Installation of the primary protective element

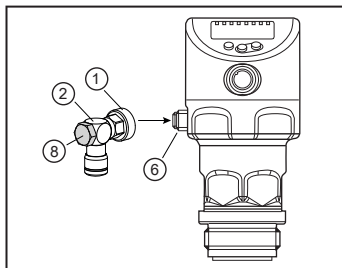

- ▶ Remove the filter cover. See: Removal of the existing filter cover (→ [7](#))
- ▶ Mount the adapter (1) and the tube connection (2) to the threaded ferrule (6).
- ▶ Loosen the locking screw (8) and turn the tube connection so that the venting faces downwards.
- ▶ Tighten the locking screw (8) with 2.5 ... 3.5 Nm.

4.6.2 Installation of the secondary protective element

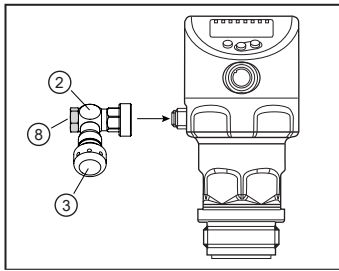

Fig. 1: Plug-in version

- ▶ Install the primary protective element. See: Installation of the primary protective element (→ 8)
- ▶ Push the plug-in element (3) into the tube connection (2) until the end stop has been reached.
- ▶ Loosen the locking screw (8) and turn the tube connection into a horizontal position so that the ventilation diaphragm in the plug-in element is in a vertical position. See: Orientation filter cover (→ 9)
- ▶ Tighten the locking screw with 2.5 ... 3.5 Nm.

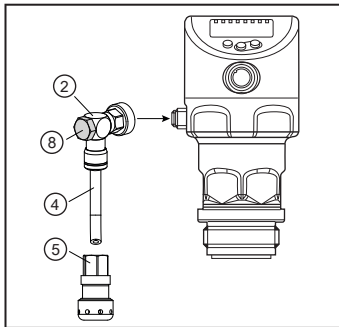

Fig. 2: Tube version

- ▶ Install the primary protective element.
- ▶ Push the vent tube (4) with plug-in element (5) into the tube connection (2) until the end stop has been reached.
- ▶ Fix the tube end with the plug-in element in a horizontal position so that the ventilation diaphragm in the plug-in element (5) is in a vertical position. See: Orientation filter cover (→ 9)



The tube must not be kinked or blocked.



The tube version can also be used without plug-in element. In this case, the open tube end has to face downwards.



A tube of any length can be used.

4.7 Orientation filter cover

Select the installation situation so that the filter cover is horizontal and the condensate can drain off due to gravity.

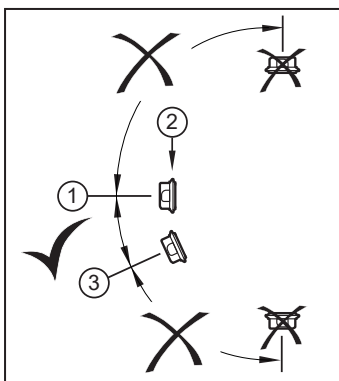

- ▶ Ideal orientation (1):
The filter cover is in a horizontal position.
- ▶ The ventilation diaphragm (2) in the filter cover is in a vertical position.
- ▶ Maximum inclination of the filter cover: 30° (3)

5 Disposal and return

- ▶ After use dispose of the unit in an environmentally friendly way in accordance with the applicable national regulations.
- ▶ In case of return shipment, ensure that the unit is free from soiling, especially from dangerous and toxic substances.