

Original operating instructions
RFID-coded safety sensor
MN7xxS

UK

80256459 / 00 03 / 2020

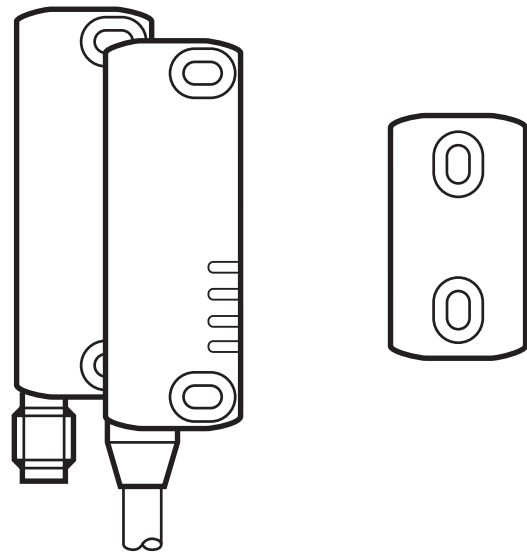

Contents

1	Preliminary note.....	3
1.1	Symbols used	3
1.2	Warning signs used	3
2	Safety instructions	4
2.1	Safety-related requirements regarding the application.....	4
2.2	Radio equipment	5
2.3	Interference of electronic and medical devices	6
3	Items supplied.....	6
4	Functions and features	6
5	Function.....	7
5.1	Limit range and operating range.....	7
6	Installation.....	8
6.1	Actuating directions	8
7	Electrical connection.....	9
7.1	Series connection	10
8	Programming	11
9	Operation	12
9.1	Switching state of the outputs.....	12
9.1.1	The safe state	12
9.1.2	The switched state.....	12
9.1.3	Cross fault / short circuit	12
9.2	Interface classification	12
9.2.1	Identification key	12
9.3	LED display	13
9.3.1	5-wire design	13
9.3.2	8-wire design	14
10	Technical data.....	15
11	Troubleshooting	17
12	Maintenance, repair and disposal.....	17
13	Terms and abbreviations.....	17

14 Approvals/standards	18
14.1 FCC Notices (USA, Canada)	18

1 Preliminary note

The instructions are part of the unit. They are intended for authorised persons according to the EMC, Low Voltage and Machinery Directive and safety regulations. The instructions contain information about the correct handling of the product. Read the instructions before use to familiarise yourself with operating conditions, installation and operation.

Follow the safety instructions.

UK

1.1 Symbols used

▶ Instructions

> Reaction, result

→ Cross-reference



Important note

Non-compliance may result in malfunction or interference.



Information

Supplementary note.



LED lights green



LED lights red



LED lights orange



LED lights green, red or orange



LED flashes



LED off

1.2 Warning signs used

WARNING

Warning of serious personal injury.

Death or serious irreversible injuries may result.

2 Safety instructions

- Follow the operating instructions.
- Improper use may result in malfunctions of the unit. This can lead to personal injury and/or damage to property during operation of the machine. For this reason note all remarks on installation and handling given in this document. Also adhere to the safety instructions for the operation of the whole installation.
- In case of non-observance of notes or standards, especially when tampering with and/or modifying the unit, any liability and warranty is excluded.
- If the sensor is damaged, the safety function cannot be guaranteed.
- Errors caused by damage cannot be detected by the sensor.
- The unit must be installed, connected and put into operation by a qualified electrician trained in safety technology.
- The applicable technical standards for the corresponding application must be complied with.
- For installation the requirements according to EN 60204 must be observed.
- In case of malfunction of the unit please contact the manufacturer. Tampering with the unit is not allowed.
- Disconnect the unit externally before handling it. Also disconnect any independently supplied relay load circuits.
- After installation, maintenance or repair of the system perform a complete function check.
- Only use the unit under the specified operating conditions (→ 10 Technical data). In case of special operating conditions please contact the manufacturer.
- Use only as described below (→ 4).

2.1 Safety-related requirements regarding the application

It must be ensured that the safety requirements of the respective application correspond to the requirements stated in these instructions.

! WARNING

Failure of the safety function

When used outside of the defined environmental conditions, the safety-related function of the sensor cannot be guaranteed.

- ▶ Use only in accordance with the defined environmental conditions (→ 10 Technical data).

Use of the sensor in the vicinity of chemical and biological media (solid, liquid, gaseous) as well as ionising radiation is not permitted.

Observe the following requirements:

- ▶ Only use cable glands, insulation material and connection wires that have an appropriate protection rating.
- ▶ Adhere to ISO 14119 for interlocking devices associated with guards.
- ▶ Adhere to the principle of normally closed operation for all external safety circuits connected to the system.
- ▶ The device must not be installed or operated in the environment of strong magnetic fields.
- ▶ Do not use the device as an end stop.
- ▶ In case of faults within the sensor which result in the defined safe state: Take measures to maintain the safe state when the complete control system continues to be operated.
- ▶ Sensors and actuators must be protected from strong shocks and vibrations. Observe the permissible environmental conditions (→ 10 Technical data).
- ▶ Annual function test (→ 12 Maintenance, repair and disposal).
- ▶ Replace damaged units.

2.2 Radio equipment

In general, the device must not be used in the vicinity of petrol stations, fuel depots, chemical plants or blasting operations.

- ▶ Do not transport and store any flammable gases, liquids or explosive substances near the unit.

2.3 Interference of electronic and medical devices

Operation of the unit can affect the function of electronic devices that are not correctly shielded.

- ▶ Disconnect the device in the vicinity of medical equipment.
- ▶ Contact the manufacturer of the corresponding device in case of any interference.

3 Items supplied

1 RFID-coded safety sensor, 1 RFID-coded actuator,
4 washers, 8 cover caps,
1 x original operating instructions, ident number 80256459.

If one of the above-mentioned components is missing or damaged, please contact one of the ifm branch offices.

4 Functions and features

RFID-coded safety sensors detect the corresponding actuators (ID-tags) without contact.

Coding levels according to EN ISO 14119:

Sensor type	Performance	Coding level
Coded	Each sensor recognises each actuator of this type.	low
Codable	The sensor can be programmed for a specific actuator.	low
Unique coding	The sensor only detects the actuator with the corresponding coding.	high

Safety-related function SF: The safe state (output stage switched off; Logic "0") is achieved if the distance to the actuator is greater than or equal to the safe switch off distance s_{ar} (→ 10 Technical data).

- ▶ Observe the notes on installation (→ 6 Installation).

The RFID-coded safety sensor has been certified by TÜVSüd.

5 Function

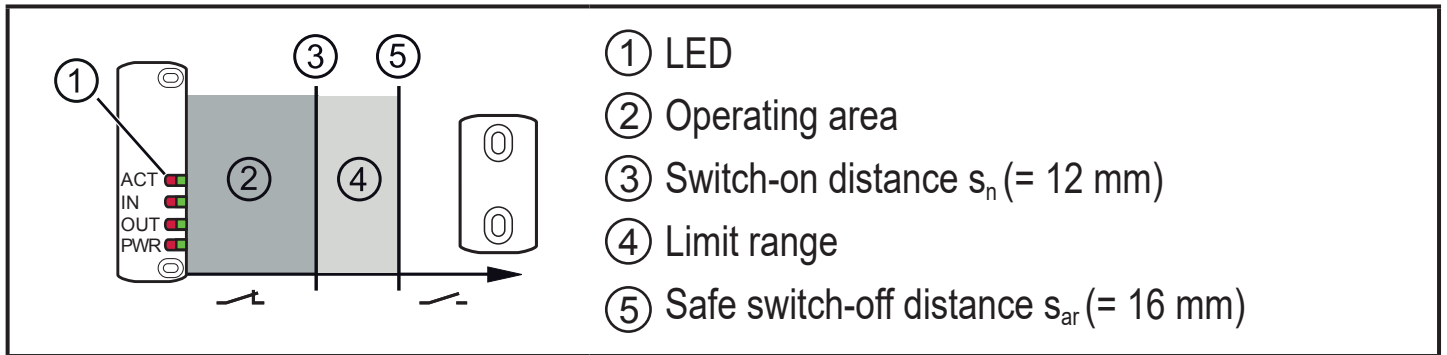

5.1 Limit range and operating range

LED states when aligning the sensor with the actuator

UK

Status	Description	LED			
		PWR	OUT	IN *	ACT
	Actuator outside the limit area ④ Nominal voltage connected > Inputs active > Outputs deactivated				
	Actuator within the actuating area ② > Outputs activated				
	Actuator leaves actuating area ② and is in the limit area ④ > Outputs remain active				
	The distance of the actuator to the sensor is larger than or equal to s_{ar} ⑤ > Outputs deactivated				

*) LED [IN] is not on in case of MN700S and MN703S.



Approach curves of the sensors at www.ifm.com:
→ General information about mounting and operation

6 Installation

6.1 Actuating directions

The sensor recognises the actuator from three different directions ②.

- ▶ When mounting the device, align the central marks ① of the sensor and the actuator in parallel to each other.

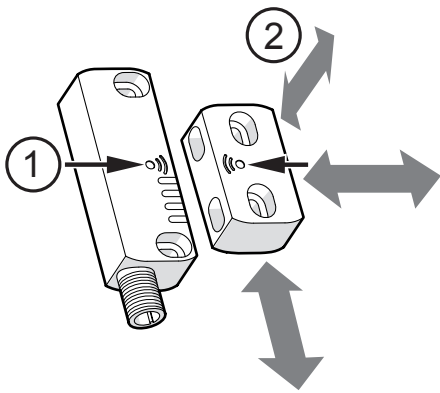

- ① Reference marks (central mark)
- ② Actuating direction



The actuator must not touch the sensor during operation.
Do not use as an end stop.

- Do not adjust the device using mechanical force.
- Only mount on a flat surface to avoid damage or changes of the sensing range.



When using several sensors, a minimum distance of 50 mm in each direction must be maintained.

- ▶ Fasten the sensor and the actuator with two screws each (M4, > 18 mm) (tightening torque 0.8...2 Nm).



Using less than two screws for each component is not permissible.
According to EN ISO 14119, the actuator must be fixed immovably.

Safety screws with one-way heads, rivets or the like are to be used.

After mounting, insert the supplied cover caps to make it more difficult to access screws or rivets.

7 Electrical connection



In case of a single fault, the supply voltage must not exceed a maximum of 60 V DC. (This requires the safe separation between power supply and transformer SELV / PELV.)

- ▶ Disconnect power. Also disconnect any independently supplied relay load circuits.

Cable	Connector
BK: black RD: red BN: brown VT: violet BU: blue WH: white	
<p>PVC cable, 6 x 0.5 mm²</p>	<p>M12 connector, 5-pole</p>
<p>PVC cable, 8 x 0.34 mm²</p>	<p>M12 connector, 8-pole</p>

- ① Safety-related logic unit
- ② Programmable Logic Controller (PLC)
- ③ Programming input (MN702S, MN705S)



When connected directly to a controller both IN1 and IN2 must be connected.

The maximum permitted cable length is 50 m.

UK

7.1 Series connection

General

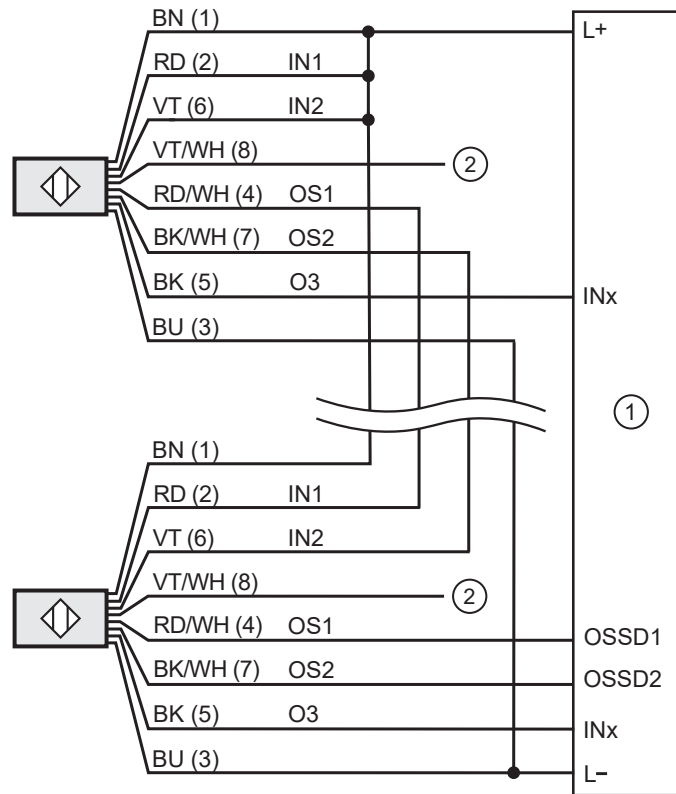

G150xS

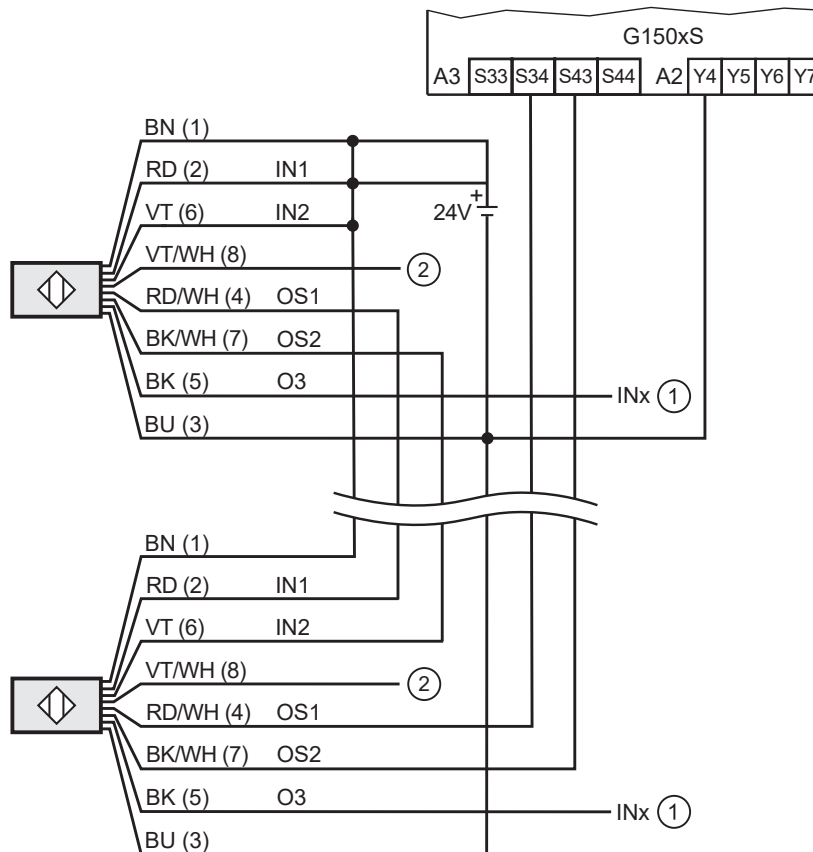

- ① external controller
- ② programming input for codable sensors



Connect maximum 32 sensors in series.

8 Programming

The programmable version of the sensor is provided with a special programming input (IN3) that recognises the stored code in a new actuator.

The programming can be repeated as often as you like. After successful programming, the sensor will only recognise the code of the most recently programmed actuator.



The sensor may only be programmed by qualified staff.

UK

PWR	LED			Status	Description
	OUT	IN	ACT		
				Switch-on operation	▶ Connect the sensor to the nominal voltage. > The device executes internal tests.
				Operation	Waiting for the input signal.
				Operation	Input signals available. Waiting for actuator.
				Programming	▶ Activate the programming input IN3 by connecting the nominal voltage (> 3 s). > Waiting for actuator.
				Programming	▶ Hold the new actuator to the sensor. > New code is successfully stored.
				Programming	▶ Deactivate programming input IN3. > Programming finished.
				Switch-on operation	Automatic restart > The device executes internal tests.

LED green

LED red

LED orange

LED flashes

LED green, red or orange

LED off

- ▶ After successful programming, test if the new actuator is recognised and the sensor functions properly.

9 Operation

9.1 Switching state of the outputs

9.1.1 The safe state

The safe state is when the output is switched off (zero-current state: Logic "0") of at least one of the outputs OS1 or OS2 (OSSDs).

If one of the outputs OS1 or OS2 is switched off, the subsequent safety-related logic unit must bring the complete system into the state defined as safe.

9.1.2 The switched state

If the coded actuator is in the enable zone and if there is no sensor error, both outputs OS1 and OS2 (OSSDs) are enabled (logic "1").

9.1.3 Cross fault / short circuit

- A cross fault between both outputs (OS1 and OS2) is detected by the fail-safe sensor and results in the outputs (OSSD) being switched off. The outputs OS1 and OS2 remain switched off until the error has been removed or a voltage reset has been carried out.
- A cross fault (short circuit) between one of the two outputs (OS1 or OS2) and the supply voltage results in the other output (OS2 or OS1) being switched off.

9.2 Interface classification





























The interface complies with interface type C class 2 according to the ZVEI position paper CB24I Ed. 2.0.

9.2.1 Identification key

	Interface type		Suitable interface type	
Source:	C2	Receiver:	C1	C2

9.3 LED display

9.3.1 5-wire design

LED				Status	Description
PWR	OUT	IN	ACT		
				Off	Device switched off.
				Switch-on operation	Internal tests when switched on.
				Operation	<ul style="list-style-type: none"> • Actuator outside the area of safe activation • Output O3 switched off.
				Operation	<ul style="list-style-type: none"> • Safety outputs activated • Actuator in the safe area • Output O3 activated
				Operation	<ul style="list-style-type: none"> • Actuator in the limit area • Output O3 activated <p>▶ Bring the actuator into the safe area.</p>
				Error	<p>Error at the outputs.</p> <p>▶ Check if there are any short circuits.</p> <p>▶ Restart the device.</p>
				Error	<p>▶ Restart the device.</p> <p>▶ Replace the device if the error occurs again.</p>

 LED green

 LED red

 LED orange













































 LED flashes

 LED green, red or orange

 LED off

UK

9.3.2 8-wire design

PWR	LED			Status	Description
	OUT	IN	ACT		
				Off	Device switched off.
				Switch-on operation	Internal tests when switched on.
				Operation	<ul style="list-style-type: none"> Inputs inactive Safety outputs switched off
				Operation	<ul style="list-style-type: none"> Inputs inactive Actuator outside the area of safe activation Safety relays and output O3 switched off
				Operation	Inputs active
				Operation	Errors at the inputs. ► Verify the activation of the input signals and the circuits of the inputs.
				Operation	<ul style="list-style-type: none"> Actuator in the safe area Output O3 activated
				Operation	<ul style="list-style-type: none"> Actuator in the limit area Output O3 activated ► Bring the actuator into the safe area.
				Operation	<ul style="list-style-type: none"> Inputs active Actuator in the safe area Safety outputs activated
				Error	Error at the outputs. ► Check if there are any short circuits. ► Restart the device.
				Error	► Restart the device. ► Replace the device if the error occurs again.

 LED green

 LED red

 LED orange

 LED flashes

 LED green, red or orange

 LED off

10 Technical data

Electrical data	
Electrical design	DC PNP
Operating voltage	20.4...26.4 V DC
Rated insulation voltage	32 V DC
Current consumption	< 50 mA
Protection class	III
Reverse polarity protection	yes
Utilisation category	DC12
Operating current	40...700 mA
No-load current	30 mA
Outputs	
Voltage drop	1.5 V
Leakage current	0.5 mA
Current rating	50 mA
Short-circuit protection	Yes
Overload protection	Yes
Switching frequency	1 Hz
Max. capacitive load $_{CL_max}$	200 nF
Detection zone	
Sensing range s_n (with coded actuator)	12 mm
Safe switch-off distance s_{ar}	16 mm
Accuracy / deviations	
Hysteresis	$\leq 20 \% S_n$
Repeatability	$\leq 10 \% S_n$
Response times	
Power-on delay time	1.5s
Response time to safety request (response time of the semiconductor outputs after the actuator is moved away $> s_{ar}$)	< 160 ms
Response time when approaching the actuation area (enable time)	< 600 ms
Risk time (response time for safety-related faults)	< 10 ms

UK

Environmental conditions	
Application (according to EN 60654-1)	class C
Ambient temperature for service life ≤ 87600 h for service life ≤ 175200 h	-25...70 °C 10...40 °C
Max. perm. relative humidity short time permanent	5...95 % 5...70 %
Air pressure	80...106 kPa
Height above sea level	< 2000 m
Ionising radiation	not permissible
Salt spray	no
Protection rating (protected cable laying)	IP 67 / IP 69K
Degree of soiling	3
Approvals / tests	
EMC	IEC 60947-5-2
Shock resistance (EN 60068-2-27)	30 g (11 ms)
Vibration resistance (IEC 60068-2-6)	10 g (10...55 Hz)
Safety classification	
EN ISO 13849-1: 2015	category: 4 PL: e
IEC 61508	SIL 3
IEC 62061	SIL _{cl} 3
Mission time T _M	≤ 175200 h (20 years)
Safety-related reliability PFH _D	1.5E-09
Mechanical data	
Installation	non flush mountable
Housing materials	PA
Tightening torque	0.8...2 Nm

11 Troubleshooting

LED display → 9.3

Problem	Possible cause	Troubleshooting
No LED display	No voltage supply	Apply voltage
LED [OUT] flashes red	Shorts circuit to earth, output or power supply	Reboot the device
LED [PWR] flashes red	Internal fault	Reboot the device
Unit does not switch / Only one output switches	An error occurred, e.g. cross fault / short circuit	<ul style="list-style-type: none"> • Remove the cross fault • Check cables • Check controller • Restart system • if necessary, replace device

UK

12 Maintenance, repair and disposal

The function of the devices must be tested automatically or manually at least once a year. The function can be tested by removing the actuator ($> s_{ar}$) (→ 5 Function).

Only the manufacturer is allowed to repair the unit.

Dispose of the unit in an environmentally friendly way in accordance with the applicable national regulations when it is no longer used.

13 Terms and abbreviations

OSSD	Output Signal Switching Device	Output signal switch element
PDDb	Proximity devices with defined behaviour under fault conditions	Näherungsschalter mit einem definierten Verhalten unter Fehlerbedingungen
PFH (PFH _D)	Probability of (dangerous) Failure per Hour	Probability of (dangerous) Failure per Hour
PL	Performance level	PL to EN ISO 13849-1
S _{ar}	Safe switch-off distance	Distance to the sensing face outside which the absence of the magnet deactivates (safe state) a subsequent evaluation unit.

SIL	Safety Integrity Level	Safety integrity level SIL 1-4 according to IEC 61508. The higher the SIL, the lower the probability that a safety function will fail.
SIL _{cl}	Safety Integrity Level _{claim limit}	Safety integrity level _{claim limit} (according to IEC 62061)
T _M	Mission time	Mission time according to EN 60947-5-3 (= max. service life)

14 Approvals/standards

14.1 FCC Notices (USA, Canada)

This device complies with Part 15 of the FCC Rules. Operation presupposes the two following conditions:

1. This device must not cause harmful interference, and
2. this device must tolerate interference including interference possibly causing undesired operation.

Warning:

Any changes made to this device without express consent of ifm electronic gmbh may invalidate FCC approval to operate this device.

Note:

This equipment has been tested and found to comply with the limits for a Class B digital device, pursuant to part 15 of the FCC Rules.

These limits are designed to provide reasonable protection against harmful interference in a residential installation.

This equipment generates, uses and can radiate radio frequency energy and, if not installed and used in accordance with the instructions, may cause harmful interference to radio communications. However, there is no guarantee that interference will not occur in a particular installation.

If this equipment does cause harmful interference to radio or television reception, which can be determined by turning the equipment off and on, the user is encouraged to try to correct the interference by one or more of the following measures:

- Reorient or relocate the receiving antenna.
- Increase the separation between the equipment and receiver.
- Connect the equipment into an outlet on a circuit different from that to which the receiver is connected.

- Consult the dealer or an experienced radio/TV technician for help.

More information at www.ifm.com

UK